 GUANGDONG DONE POWER TECHNOLOGY CO.,LTD <small>Service hotline: 400 0760 585 Website: www.donepower.com.cn</small>	Application	DONE WATERPROOF LED DRIVER		
	Product Line	DL-75W-S/A-MAP	REV.	1.4

Guangdong Done Power Technology Co., Ltd.

SPECIFICATION FOR APPROVAL

CUSTOMER	
MODEL NO.	DL-75W-S/A-MAP
VERSION	V1.4
SAMPLE DATE	

CUSTOMER

TEST	CHECK	APPROVE
CUSTOMER REMARKS		

Please return to us one copy of "SPECIFICATION FOR APPROVAL" with you approved signature.

MANUFACTURE

EDIT	CHECK	APPROVE
吕晓凤		

Guangdong Done Power Technology Co.,Ltd.

No. 3-1&3-2, Kanglong 3rd Road, XinMao Industry Zone, Henglan Town,
 Zhongshan City, Guangdong Province, P. R. China Post code:528478
 TEL:0760-89838399 89838379 FAX:0760-89831157 89838396

 GUANGDONG DONE POWER TECHNOLOGY CO.,LTD <small>Service hotline: 400 0760 585 Website: www.donepower.com.cn</small>	Application	DONE WATERPROOF LED DRIVER		
	Product Line	DL-75W-S/A-MAP	REV.	1.4

■ VERSION

DATE	CAUSES OF CHANGE	REV.	CHECK
2020.01.15	Initial version.	V1.0	
2020.03.20	Change the picture of product (P3) .	V1.1	
2020.04.14	Add voltage range on page 4:90-305Vac.	V1.2	
2020.05.16	Change the picture of product (P3) Add the ENEC logo (P3) and warning (P13) .	V1.3	
2022.3.11	1.modify dimension drawing: input and output skinning length changed from 5mm to 10mm 2. update the company LOGO and company name.	V1.4	

 GUANGDONG DONE POWER TECHNOLOGY CO.,LTD Service hotline: 400 0760 585 Website: www.donepower.com.cn	Application	DONE WATERPROOF LED DRIVER		
	Product Line	DL-75W-S/A-MAP	REV.	1.4

■ FEATURES

- ◇ Class I structure
- ◇ Input Voltage:100-277V ~ 50/60Hz
- ◇ Efficiency 88%
- ◇ Constant power drive , Constant current output control mode
- ◇ Metal clad construction , level of protection : IP67
- ◇ Lightning protection level : difference module 4kV , common mode 6kV
- ◇ Long life design , 5 years warranty
- ◇ Output current can be adjusted Externally
- ◇ The dimming function : Three in one dimming (Only S series)



■ TYPICAL APPLICATIONS

Road lighting、Industrial lighting、The venue lighting
floodlighting、landscape lighting



■ MODEL LIST

Model	AC Input	Output power	Output voltage	Output current	Efficiency	T.H.D	PF
DL-75W-V38S-MAP DL-75W-V38A-MAP	100-277Vac 50/60Hz	75W	20-38Vdc	2.4A	>88%	<10%	>0.95
DL-75W-V58S-MAP DL-75W-V58A-MAP	100-277Vac 50/60Hz	75W	32-58Vdc	1.8A	>88%	<10%	>0.95

NOTE :

1. Default tested at 230Vac,full load with 30 minutes,Ta:25°C.
2. Vin<180Vac±5% , Pout decreased gradually Vin=150V, Pout:37.5W±20% ; Vin:200-277Vac , Prated 75W. Special attention should be paid to the application.

 GUANGDONG DONE POWER TECHNOLOGY CO.,LTD Service hotline: 400 0760 585 Website: www.donepower.com.cn	Application	DONE WATERPROOF LED DRIVER		
	Product Line	DL-75W-S/A-MAP	REV.	1.4

■ SPECIFICATION

◇ INPUT

Rated voltage	100- 277Vac
Voltage Range	90-305Vac
Frequency	50/60Hz
Power factor(PF)	PF>0.95 @230Vac full load
Total harmonic distortion(THD)	THD<10% @230Vac full load
Input current	I_{in} <0.8A @180Vac full load
Inrush current (typ.)	Cold start 70A @230Vac

◇ OUTPUT

Model	DL-75W-V38S-MAP DL-75W-V38A-MAP	DL-75W-V58S-MAP DL-75W-V58A-MAP
Rated current	2A	1.3A
Output current range	1.3-2.5A	0.9-1.8A
Output voltage range	20-38Vdc	32-58Vdc
Rated output power(100-180Vac)	37.5W±20%	37.5W±20%
Rated output power(200-277Vac)	75W	75W
No load voltage	50Vdc Max	70Vdc Max
Efficiency	88%@230Vac Full load	88%@230Vac Full load
Accuracy off output current	±5%	
Line regulation	±5%	
Load regulation	±5%	
Setup time	<500ms @230Vac full load	

NOTE : the range of output current is limited by in-out voltage , For details, please refer to the I-V working area.

 GUANGDONG DONE POWER TECHNOLOGY CO.,LTD Service hotline: 400 0760 585 Website: www.donepower.com.cn	Application	DONE WATERPROOF LED DRIVER		
	Product Line	DL-75W-S/A-MAP	REV.	1.4

◇ Others

0-10V Dimming (Optional)	Safety Dimming Voltage Range	0V - 12V
	Dim Range	0 - 100%
	Rated Dim Range	0V - 10V
PWM Dimming (Optional)	PWM High	9.5V - 10.5V
	PWM Low	0V - 0.3V
	PWM Frequency	300Hz - 2000Hz
	PWM Duty	0 - 100%
Resistor Dimming	Resistance	0Kohm - 100Kohm
	Dim Range	0 - 100%

NOTE:

1. Output current of dimming port: 100uA (typical value);
2. The maximum withstand voltage of the dimming port is 12V. If the external power supply voltage exceeds 12V or the signal line is reversely connected, the power supply will be damaged.

◇ Protection

Low Voltage protection	When the input voltage is less than 180Vac, the output power is reduced by about half.
Over Load protection	Protection mode: hiccup restart mode, automatic recovery after removal of abnormal load conditions.
Short Circuit Protection	Doze mode, can automatically recover after abnormal conditions are removed.
Over temperature Protection	When the Tc is over 90 °C , the output power is reduced by about half.
Over Voltage protection	Protection mode: hiccuping or clamping in output maximum voltage ,Production undamaged,When troubleshooting,Normal operation of power supply.

NOTE:

1. All specifications are tested at 230Vac (50Hz) , rated load, and Ta:25°C.
2. Including setting error, linear adjustment rate and load adjustment rate.

 GUANGDONG DONE POWER TECHNOLOGY CO.,LTD Service hotline: 400 0760 585 Website: www.donepower.com.cn	Application	DONE WATERPROOF LED DRIVER		
	Product Line	DL-75W-S/A-MAP	REV.	1.4

■ ENVIRONMENT

Working temperature	-40 ~ +60°C (Refer to "Derating Curve")
Working humidity	20 ~ 95% RH, non-condensing
Storage temperature/humidity	-40~+80°C, 10 ~ 95% RH
Resistant to vibration	10 ~ 500Hz, 5G 12min./1cycle, period for 72min. each along X, Y, Z axes
MTBF	230K hrs min. MIL-HDBK-217F (Ta=25°C)

■ SAFETY & EMC

Safety	GB19510.1、GB19510.14、EN61347-1、EN61347-2-13、IEC61347-1、IEC61347-2-13、AS/NZS61347.1、AS61347.2.13 ;
EMC	EN 55015、EN 61000-3-2 、GB/T 17743、GB17625.1、EN 61000-3-3
Surge level	difference mode L-N \pm 4 KV (2 ohm), common mode L , N-PE \pm 6KV (12 ohm) Refer to IEC61000-4-5 2014
High-pot test	I/P-O/P:3.75KVAC I/P-PE :1.5KVAC O/P-PE : 0.5KVAC I/P-DIM:1.5KVAC
Insulation resistance	I/P-O/P:100M Ohms / 500VDC / 25°C/ 70% RH
Leakage current	<0.7mA

NOTE:

The power supply is considered as a component that will be operated in combination with final equipment. Since EMC performance will be affected by the complete installation, the final equipment manufacturers must re-qualify EMC Directive on the complete installation again.

I-V Working Area

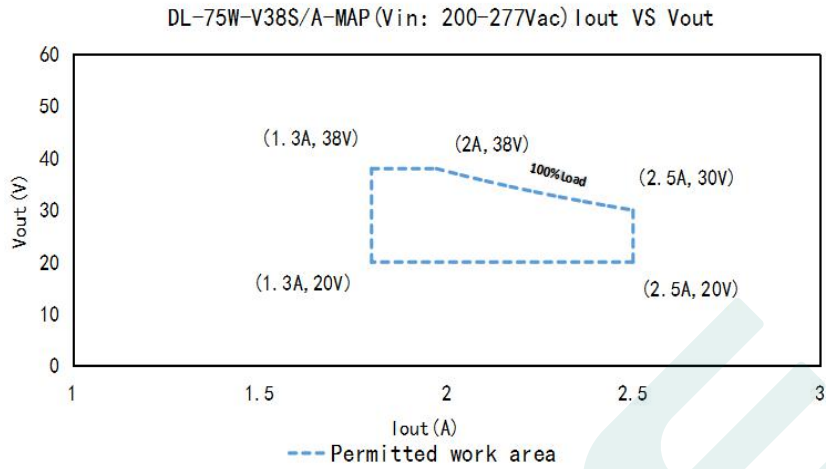

DL-75W-V38S/A-MAP(200-277Vac , Rated output current and output power corresponding to different load voltages)

Load working Voltage	20V	22V	24V	26V	28V	30V	33V	36V	38V
Io_MAX	2.5A	2.5A	2.5A	2.5A	2.5A	2.5A	2.3A	2.1A	2A
Po_MAX	50W	55W	60W	65W	70W	75W	75.9W	75.6W	76W

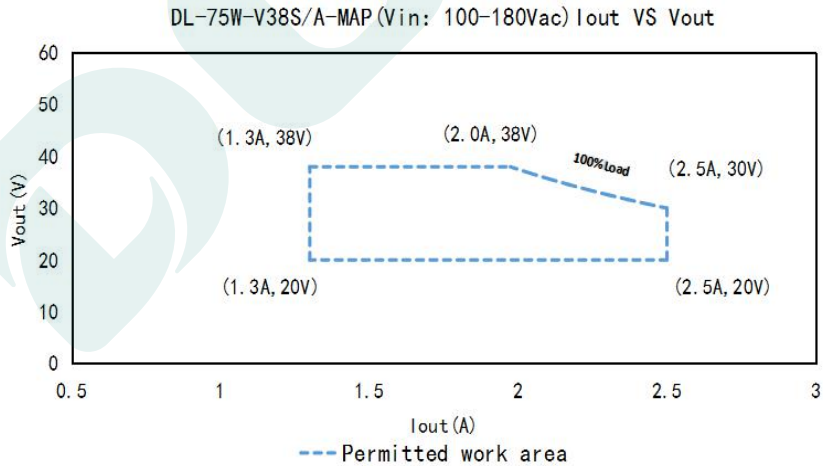

DL-75W-V38S/A-MAP(100-180Vac , Rated output current and output power corresponding to different load voltages)

Load working Voltage	20V	22V	24V	26V	28V	30V	33V	36V	38V
Io_MAX	1.25A	1.25A	1.25A	1.25A	1.25A	1.25A	1.15A	1.05A	1A
Po_MAX	25W	27.5W	30W	32.5W	35W	37.5 W	37.9W	37.8W	38W

■ I-V Working Area

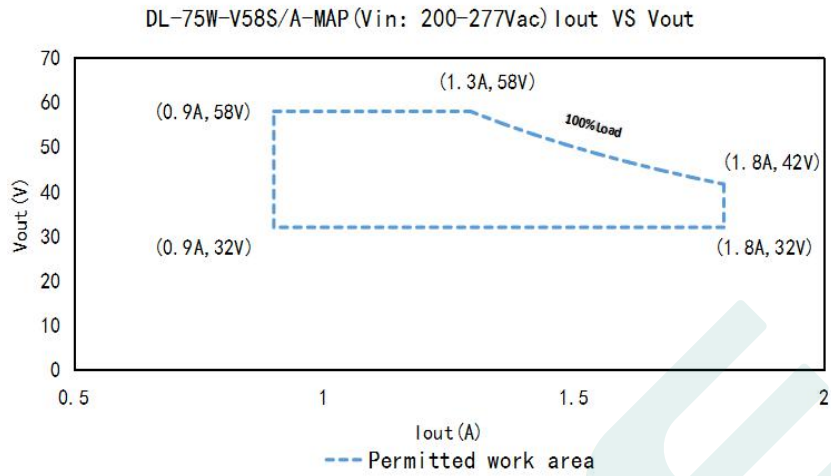

DL-75W-V58S/A-MAP(200-277Vac , Rated output current and output power corresponding to different load voltages)

Load working Voltage	32V	35V	39V	42V	45V	48V	50V	55V	58V
Io_MAX	1.8A	1.8A	1.8A	1.8A	1.67A	1.56A	1.5A	1.36A	1.3A
Po_MAX	57.6W	63W	70.2W	75.6W	75.1W	74.8W	75W	74.8W	75.4W

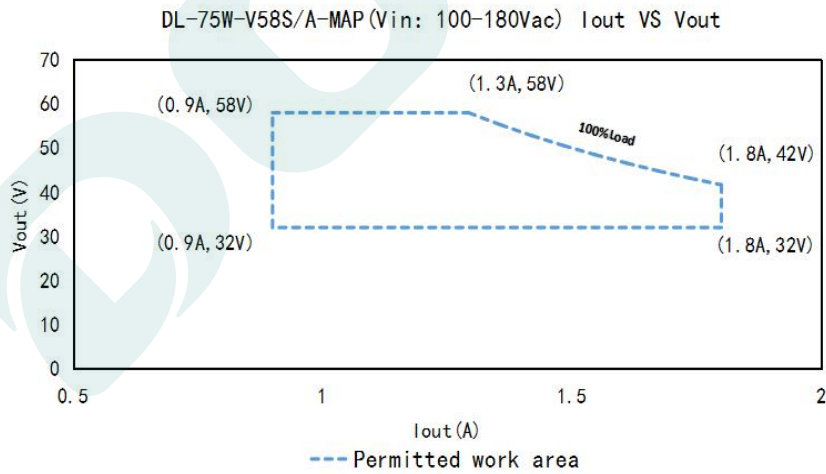

DL-75W-V58S/A-MAP(100-180Vac , Rated output current and output power corresponding to different load voltages)

Load working Voltage	32V	35V	39V	42V	45V	48V	50V	55V	58V
Io_MAX	0.9A	0.9A	0.9A	0.9A	0.83A	0.78A	0.75A	0.68A	0.65A
Po_MAX	28.8W	31.5W	35.1W	37.8W	37.3W	37.4W	39.3W	37.4W	37.7W

Efficiency VS Vout (DL-75W-V38S-MAP)

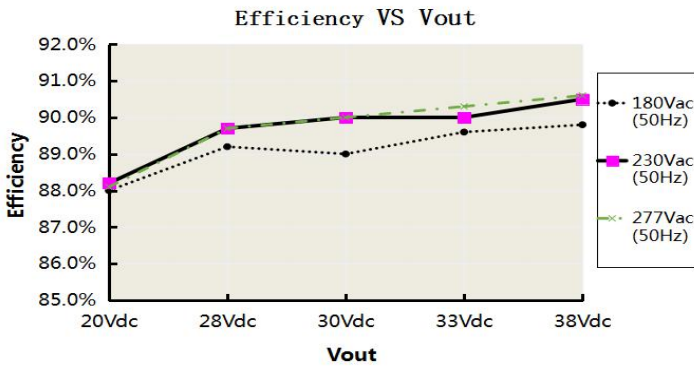

Efficiency VS Vout (DL-75W-V58S-MAP)

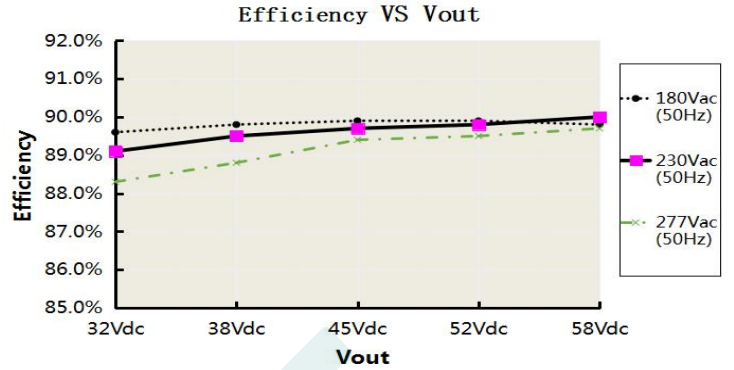

Vin VS PF (DL-75W-V38S-MAP)

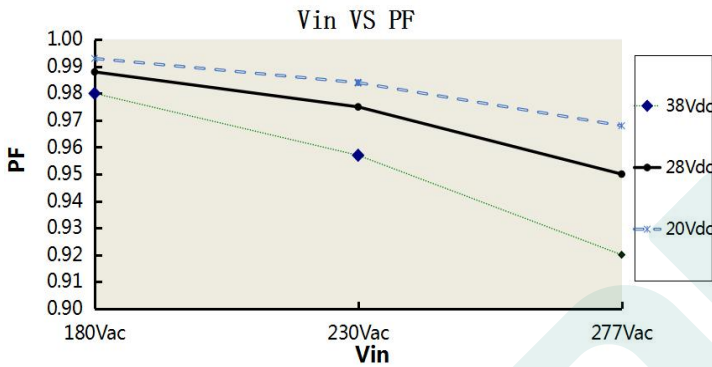

Vin VS PF (DL-75W-V58S-MAP)

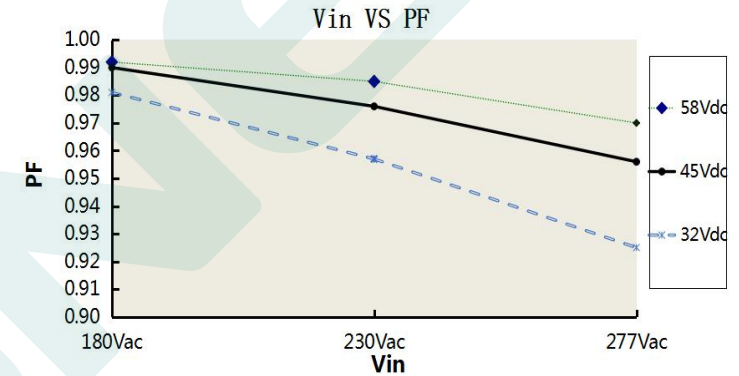

Vout VS THD (DL-75W-V38S-MAP)

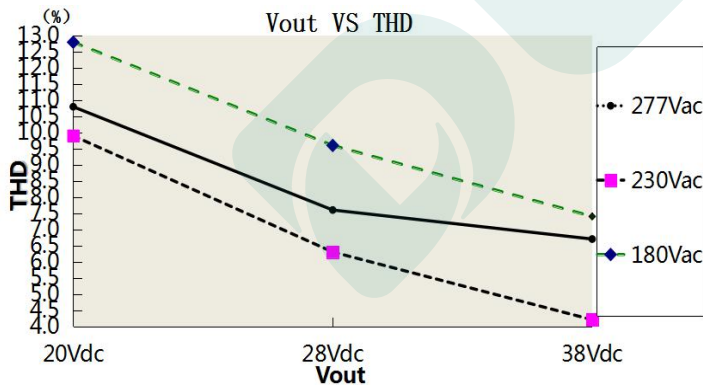

Vout VS THD (DL-75W-V58S-MAP)

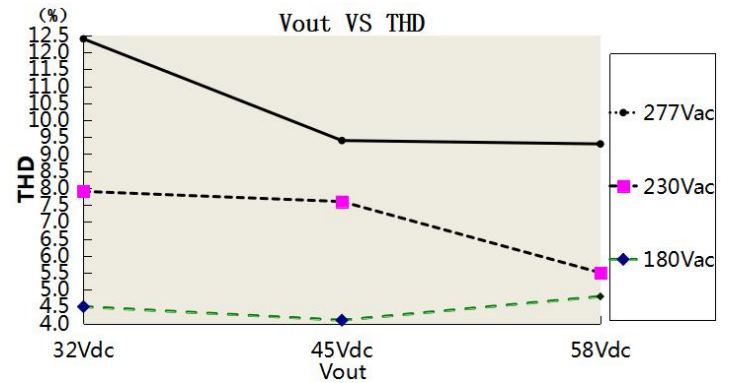

Tc VS Life (DL-75W-S/A-MAP)

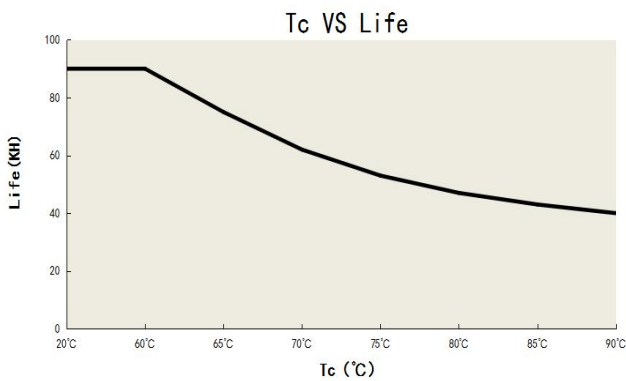

Pout VS Tc

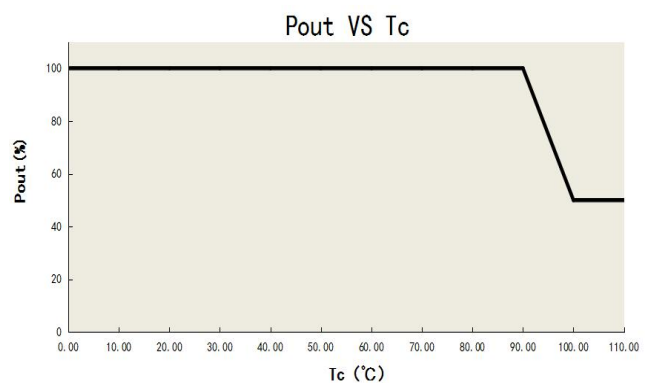

■ Pout VS Vin

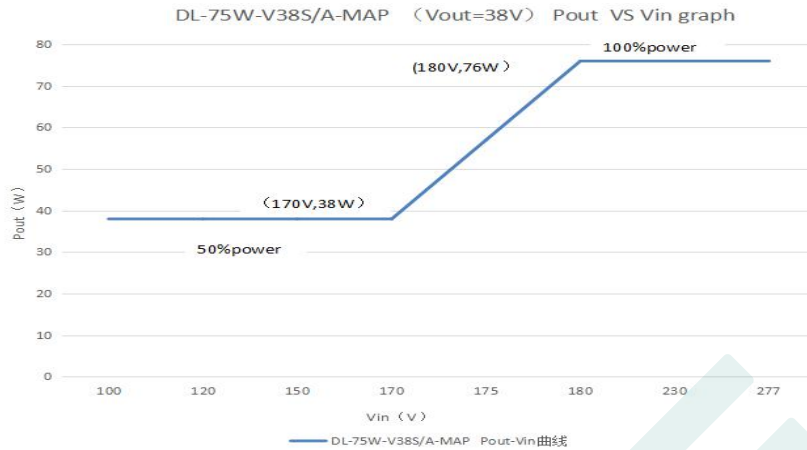

DL-75W-V38S/A-MAP(38Vdc, Rated output current and output power corresponding to different Input voltages)								
Input Voltage	100Vac	120Vac	150Vac	170Vac	175Vac	180Vac	230Vac	277Vac
Io	1A	1A	1A	1A	1.5A	2.0A	2.0A	2.0A
Po	38W	38W	38W	38W	57W	76W	76W	76W

■ Pout VS Vin

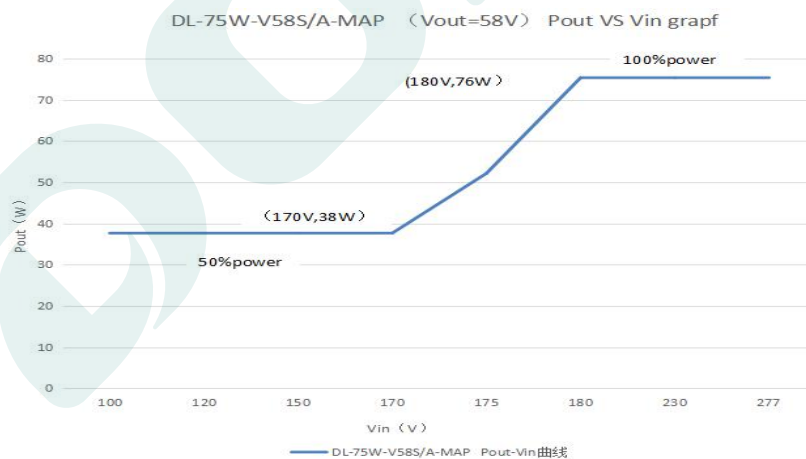

DL-75W-V58S/A-MAP(58Vdc, Rated output current and output power corresponding to different Input voltages)								
Input Voltage	100Vac	120Vac	150Vac	170Vac	175Vac	180Vac	230Vac	277Vac
Io	0.65A	0.65A	0.65A	0.65A	0.97A	1.3A	1.3A	1.3A
Po	37.7W	37.7W	37.7W	37.7W	56.5W	75.4W	75.4W	75.4W

- NOTE:
1. Due to input voltage fluctuations and resistance errors. When the power decreases or increases (that is, $V_{in} = 150V$ or $V_{in} = 180V$), it will move left and right, and the approximate moving range is $150V \pm 10\%$, $180V \pm 10\%$.
 2. When the input voltage is 100-180V, the output power range is $37.5W \pm 20\%$.

■ DIMMING OPERATION

※ 3 in 1 dimming (For S Type)

- Output constant current level can be adjusted by applying one of the three methodologies between DIM+ and DIM-: 0 ~ 10VDC, or 10V PWM signal or resistance. Direct connecting to LEDs is suggested. It is not suitable to be used with additional drivers.
- Dimming source current from power supply: 100μA (typ.)

◎ Applying additive 0-10Vdc:

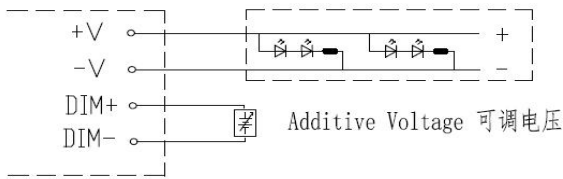

DO NOT connect "DIM- to -V" 请勿将DIM- 与-V相连

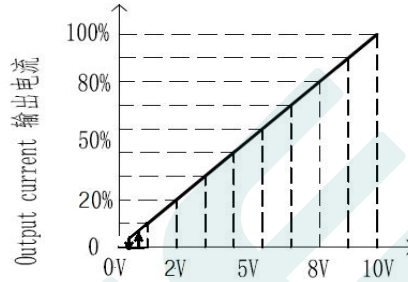

Dimming input: Additive voltage 调光输入: 外加电压

◎ Applying additive 10V PWM signal (Frequency range: 300Hz-2K Hz) :

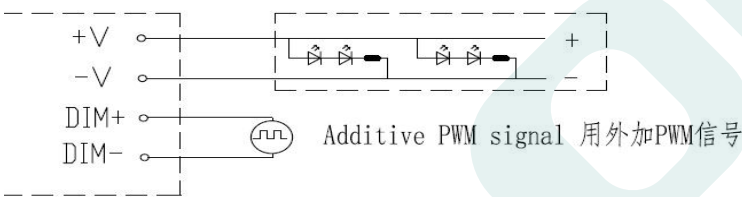

DO NOT connect "DIM- to -V" 请勿将DIM- 与-V相连

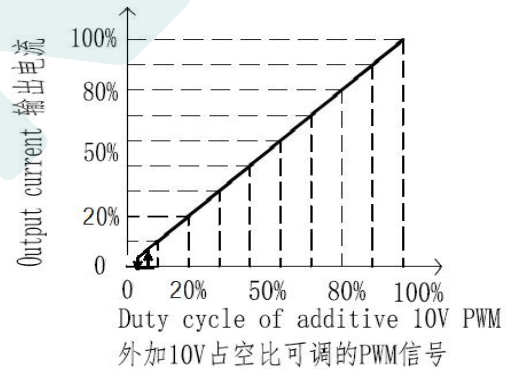

◎ Applying additive 0-100K resistance:

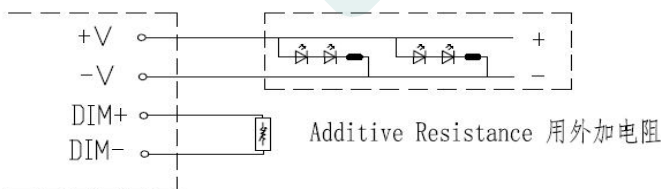

DO NOT connect "DIM- to -V" 请勿将DIM- 与-V相连

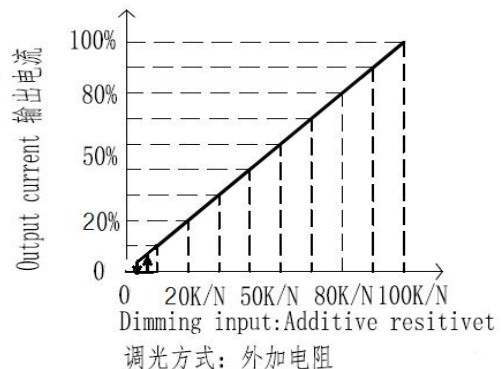

Note: N is the number of synchronously dimming actuators; Example: The number of synchronous dimming operation drives is 1, the output current is 20%, then the external resistance is: $20K/1=20K$

The number of synchronous dimming operation drives is 2, the output current is 20%, then the external resistance is: $20K/2=10K$, and so on.

■ MACHINE SIZE MAP:

Size (mm)	L143mm*W49mm*H31mm
-------------	--------------------

Case model : B60

unit:mm

DL-75W-V38A/58A-MAP

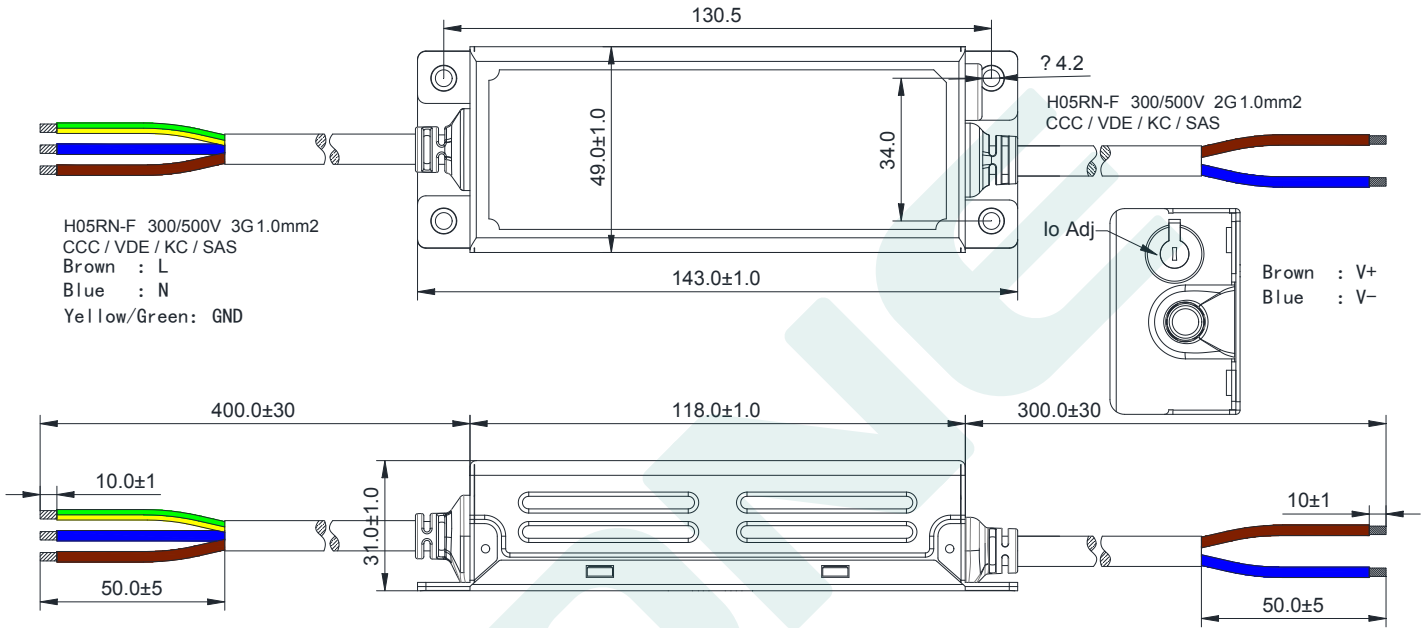

DL-75W-V38S/58S-MAP

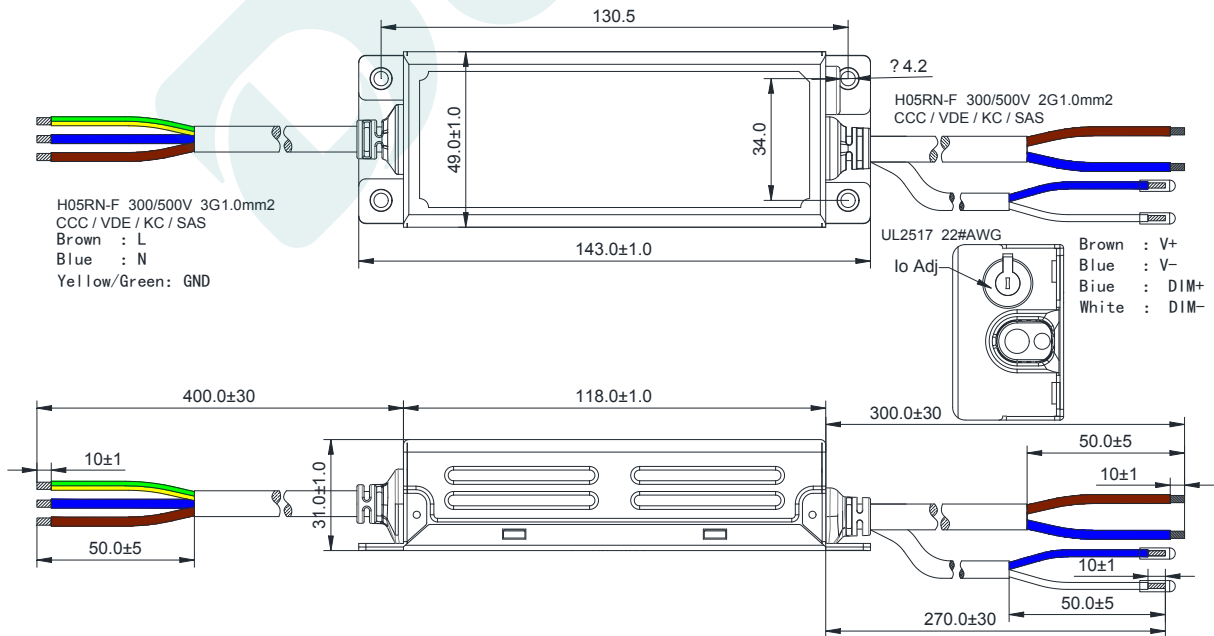

■ WEIGHT

Weight	400g/PCS
--------	----------

■ PACKAGING

Packaging (mm)	L475*W350*H205
------------------	----------------

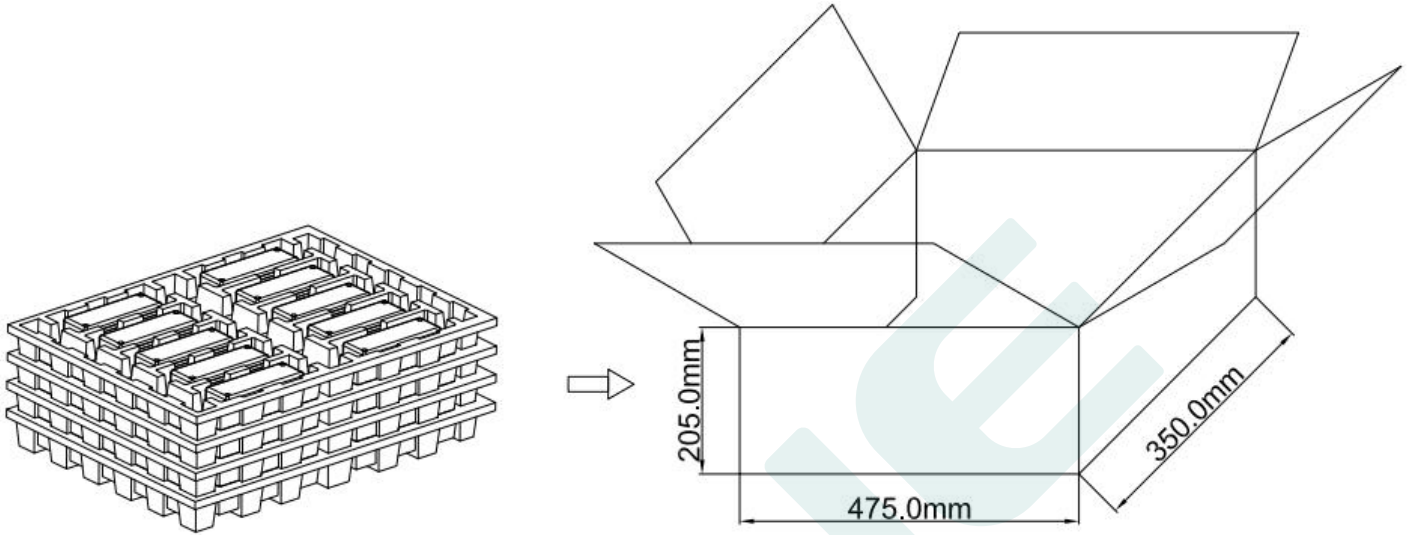

Remark : 40 drivers in a packing case

Warning:

1. According to the certificate of power supply The LED driver of English nameplate is suitable for sale to Europe, America and India;
2. LED drivers for Chinese nameplates are only available for lamps sold to China.