

The logo for DONE, featuring the word "DONE" in a bold, teal, sans-serif font. The letter "D" is stylized with a circular element on its left side. The logo is enclosed in a thin teal rounded rectangular border.

DONE

MUG SERIES LED DRIVER

DL-100U-MUG SPEC V1.1

Features

- Class I type for insulation(pending)
- Input voltage range: 277-480V ~ 50/60Hz
- Efficiency :91%(Typ.)
- Constant current output ,with power limitation for control mode
- Metal case, protection grade against water and dust: IP67
- Surge level:
 - differential mode :6kV,
 - common mode :10kV
- available version :
 - A version: Output current is dimmed by external potentiometer
 - P version: Output current is dimmed by Isolated 3 in 1 dimmer
- guaranteed Lifetime : 5 years



Applications

Street lighting、 Industrial lighting、 Venue lighting
 Floodlight lighting、 Landscape lighting 、 Plant lighting



Model list

Model NO.	Input voltage	Output power	Output voltage	The default current	Eff.	T.H.D	PF
DL-100U-V56P-MUG	277-480V 50/60Hz	100W	25-56Vdc	2.1A	≥90%	≤10%	≥0.95
DL-100U-V143P-MUG	277-480V 50/60Hz	100W	71-143Vdc	0.7A	≥90%	≤10%	≥0.95

- Note :**
1. Test conditions: Ta=25°C , under 380Vac input,after running for 30 minutes with full load .
 2. When the input is less than 240±10%Vac,the output power gradually decreases.When the input 277-480VAC,rated power 100W.
Please refer to “THE OUTPUT POWER VS INPUT VOLTAGE” curve chart for details.

Input characteristics

Parameter	Min	Typ.	Max	remark
Rated input voltage	277Vac	380Vac	480Vac	
Input voltage range	264Vac		504Vac	
Rated frequency range	47Hz	50/60Hz	63Hz	
Power factor	-	0.97	-	@380Vac input ,with full load
Power factor	0.9	-	-	@277-480Vac input ,with 65%-100% load
T.H.D.	-	-	10%	@380Vac input ,with full load
T.H.D.	-	-	20%	@277-480Vac input ,with 65%-100% load
Input current	-	-	0.6A	@277Vac input ,with full load
Inrush current	-	-	70A	380Vac, cold start (25°C)

Output characteristics

Parameter	Min	Typ.	Max	remark
Rated current				
DL-100U-V56P-MUG	-	1.8A	-	
DL-100U-V143P-MUG	-	0.7A	-	
Output current range				
DL-100U-V56P-MUG	0.8A	-	2.8A	
DL-100U-V143P-MUG	0.5A	-	1.05A	
Output voltage range				
DL-100U-V56P-MUG	25V	-	56V	
DL-100U-V143P-MUG	71V	-	143V	
Available power(277-480Vac)	-	50W	100W	Decrease to a half once input voltage being less than 240±10%Vac
Rated power(277-480Vac)	-	100W	-	
No-load voltage				
DL-150U-V56P-MUG	-	-	75V	
DL-100U-V143P-MUG	-	-	170V	

Output characteristics

Parameter	Min	Typ.	Max	Note
Efficiency@380VVac DL-100U-V56P-MUG DL-100U-V143P-MUG	89% 90%	90% 90%	-	@380Vac input ,with full load
Accuracy of output current	-5%	-	+5%	For constant-power range , with full load
Line regulation	-5%	-	+5%	full load
Load regulation	-5%	-	+5%	full load
Starting time	300ms	-	1000ms	Full load@277-480Vac
12V output voltage	10.8V	12V	13.2V	
12V output current	0 mA	-	250 mA	Reference to the“Dim-”
12V output transient peak current@6W	-	-	500 mA	In a 5.0ms cycle, the maximum duration of the maximum peak current of 500mA is 2ms, and the average value must not exceed 250mA

Note: 1.The output current is limited by the input and output voltage, please refer to “I-V WORKING AREA” for details;

Dimming characteristics

Dimming function		Min	Typ.	Max	Instructions
0-10V Dimming (Optional)	Safe operation voltage range	0V	-	12V	When the external voltage is $\geq 12V$, the dimming will fail
	Dimming output range	0%	-	100%	-
	Rated operation voltage range	0V	-	10V	It can be set to negative dimming mode through program setting
PWM Dimming (Optional)	PWM high level	9.5V	-	10.5V	-
	PWM low level	0V	-	0.5V	-
	Rated dimming frequency	300Hz	-	2000Hz	-
	PWM duty cycle	0%	-	99%	Output full power at 99% duty cycle
Resistor Dimming (Optional)	Rated external resistance value	0K Ω	-	100K Ω	-
	Dimming output range	0%	-	100%	-
Multiple time-controlled dimming (Optional)	MCU controlling		Segmented dimming function		operating mode
	Timer control		The default is six segments, Can be customized		24H to achieve a cycle

Note:

1. Output current of dimming port: 100uA (typical value);
2. The maximum voltage of the dimming port is 12V. If the external power supply voltage exceeds 12V or the signal cable is inverted, the power supply will be damaged;
3. Dimming default setting is three in one positive logic dimming (programmable software can be set to timing dimming, 0-5V or other voltage dimming);
4. When set to positive logic dimming function, the 0V dimming is turned off, and the output voltage is 0.46*Vomax after the dimming is turned off. Be careful when using this function, but customers are advised to use 1-10V dimming.
5. When setting negative logic dimming, the default output is 100% when the dimming is suspended. Negative logic dimming cannot be turned off. When the port voltage of the dimming is greater than 10.5V, the maximum power output of the power supply will be achieved.

Protection

Protection	description
Input under-voltage protection	When the input voltage is less than 240Vac± 10%, the output power gradually decreases.
Output overload protection	Protection mode:hiccup mode,recovers automatically after fault condition is removed.
Output short circuit protection	Hiccup mode:recovers automatically after fault condition is removed
Over temperature protection	Self-recovery type: when the housing temperature is greater than 90℃, the output power decreases gradually.
Output over-voltage protection	Protection mode: Hiccup mode or clamped in output highest voltage , the product is not damaged, LED driver works normally after fault condition is removed.

Note:

1. Unless otherwise specified, all parameters should be measured at the condition of 380Vac (50Hz) input ,with rated load ,and ambient temperature of 25℃;

Environmental

Environmental categories	Parameter
Working temperature	-40 ~ +55°C @200-277Vac (refer to "Life Curve ")
Safety shell temperature	-40 ~ 90°C
Working humidity	20 ~ 95% RH
Storage temperature、 humidity	-40~+80°C, 10 ~ 95% RH
Resistant to vibration	10 ~ 500Hz, 5G 12 min/cycle, X, Y, Z axis 72 min each
MTBF	230Khrs min. MIL-HDBK-217F (Ta=25°C)
Lifetime	70000 h @ housing temperature 75 °C, 380Vac, 80% load, see section "housing temperature and life"

Note:

1. Unless otherwise specified, all parameters should be measured at the condition of 380Vac (50Hz) input ,with rated load ,and ambient temperature of 25°C;

Safety and EMC

Safety categories	Standard
Safety	UL 8750
EMC	FCC Part15, Subpart B
Surge leve	Differential mode L-N ±4KV (2 ohm) ,common mode L, N-PE± 6KV (12 ohm); Refer to IEC61000-4-5 2014 Criterion B
High-pot test	I/P-O/P:3.75KVac I/P-PE :1.5KVac O/P-PE : 0.5KVac I/P-DIM:3.75KVac O/P-DIM:1.5KVac
Insulation impedance	I/P-PE:100MΩ / 500VDC; I/P-O/P:100MΩ / 500VDC / 25°C/ 70% RH
Leakage current	<0.7mA@480Vac

Note:

1.The driver is considered as a component that will be operated in combination with the final equipment. Since EMC performance will be affected by the complete installation,the final equipment manufacturers must re-qualify EMC Directive on the complete installation again.

I-V Working area

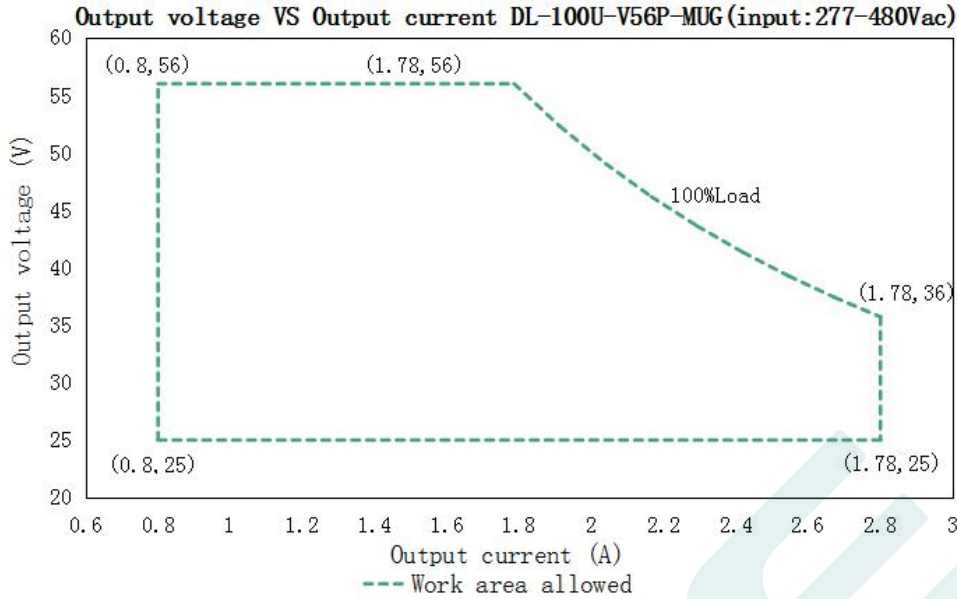

Load	Output								
Load working Voltage	25V	29V	33V	36V	40V	44V	48V	52V	56V
Io_MAX	2.8A	2.8A	2.8A	2.8A	2.5A	2.3A	2.1A	1.92A	1.8A
Po_MAX	48.5W	51.3W	55W	100W	100W	100W	100W	100W	100.8W

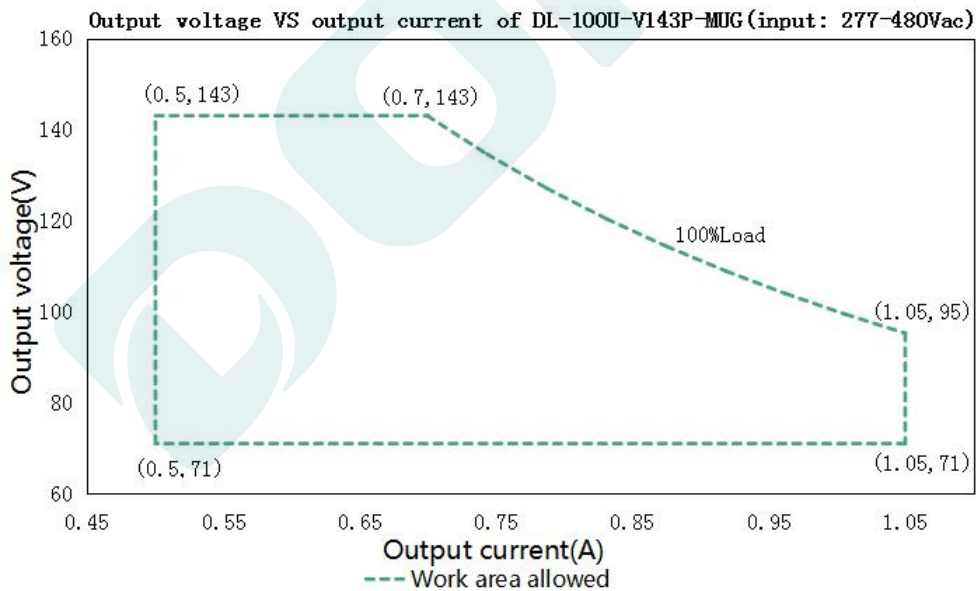

Load	Output								
Load working Voltage	71V	79V	87V	95V	108V	116V	125V	134V	143V
Io_MAX	1.05A	1.05A	1.05A	1.05A	0.926A	0.862A	0.8A	0.746A	0.7A
Po_MAX	74.55W	82.9W	91.35W	100W	100W	100W	100W	99.96W	100.8W

Eff. VS Output voltageDL-100U-V56P-MUG

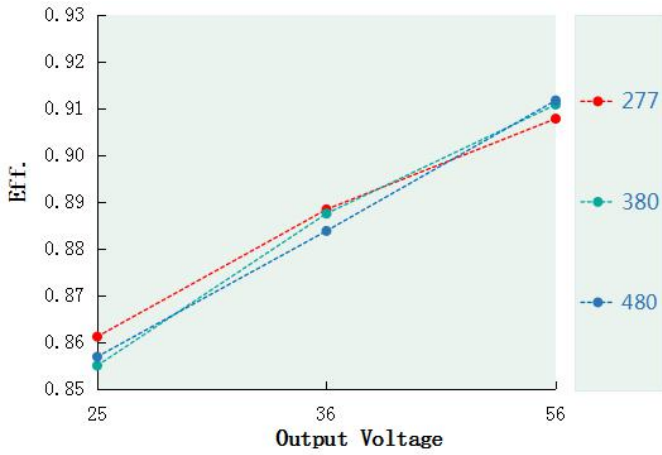

Eff. VS Output voltageDL-100U-V143P-MUG

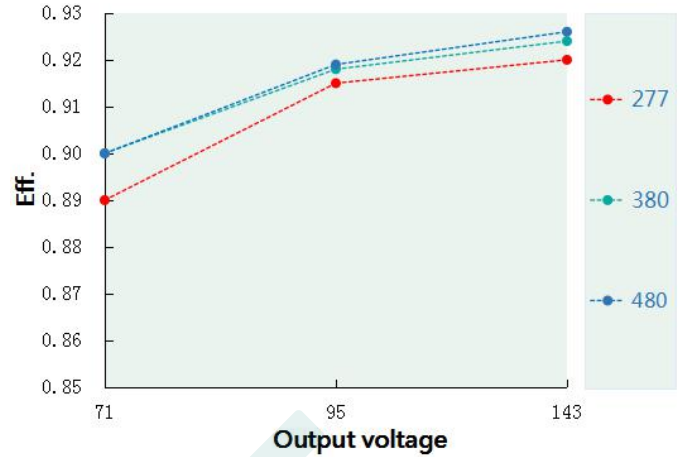

Power factor VS Input voltageDL-100U-V56P-MUG

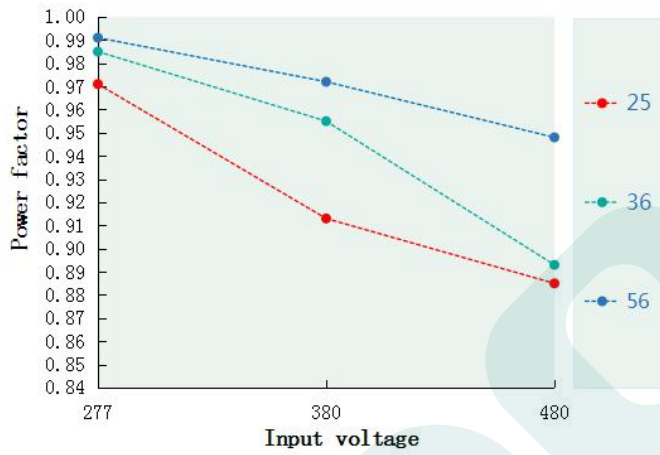

Power factor VS Input voltageDL-100U-V143P-MUG

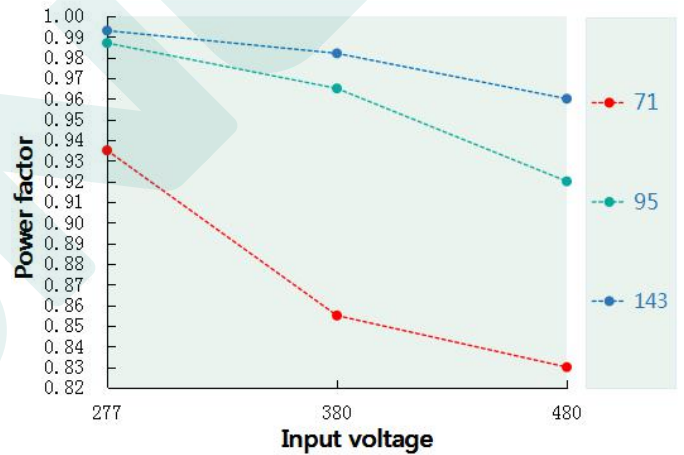

T.H.D. VS Output voltage(DL-100U-V56P-MUG)

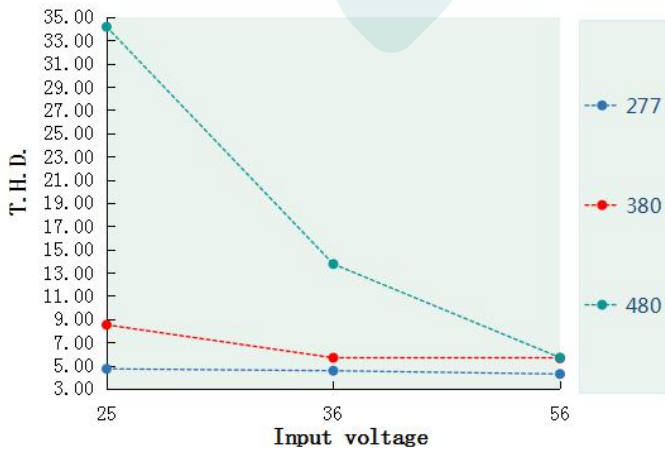

T.H.D. VS Output voltage(DL-100U-V143P-MUG)

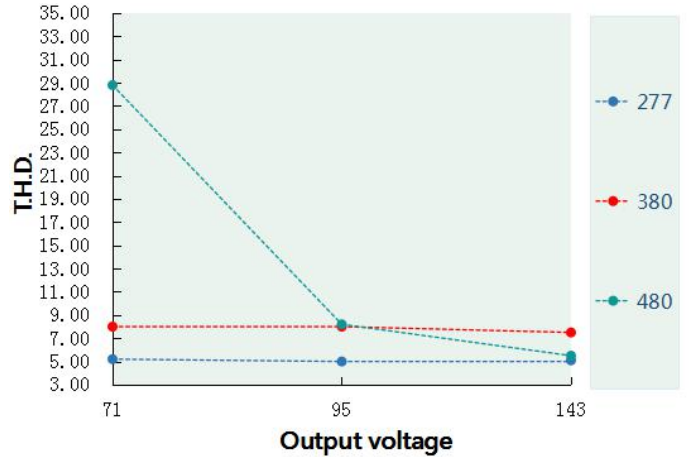

Tcase VS Lifetime(DL-100U-V56P-MUG)

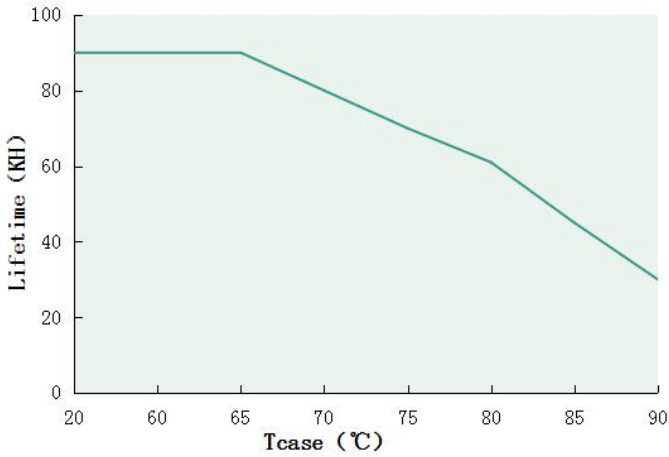

Tcase VS Lifetime(DL-100U-V143P-MUG)

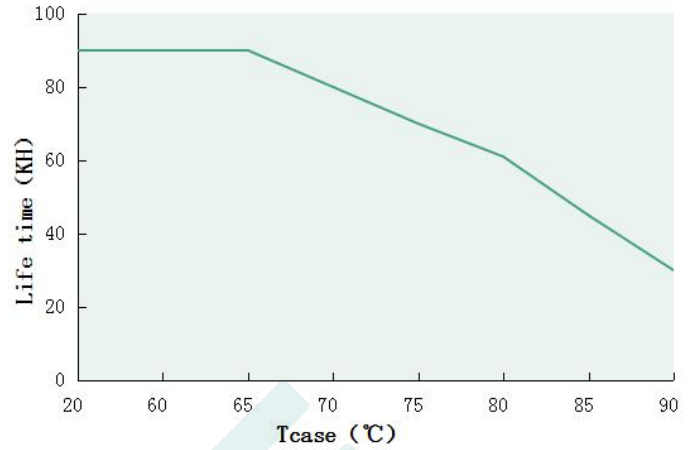

Output power VS Tcase (DL-100U-V56P-MUG)

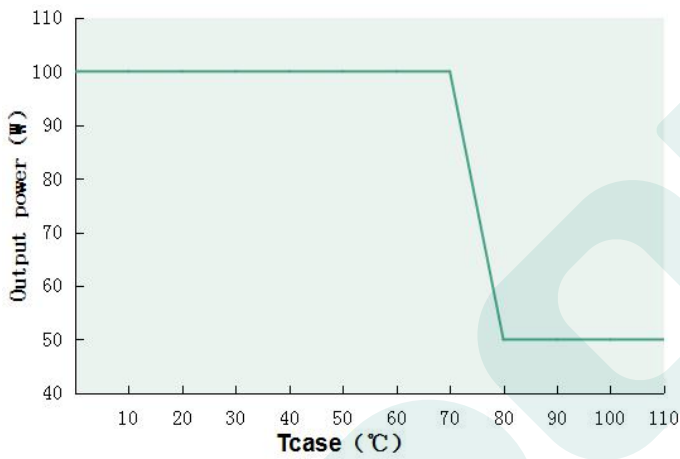

Output power VS Tcase (DL-100U-V143P-MUG)

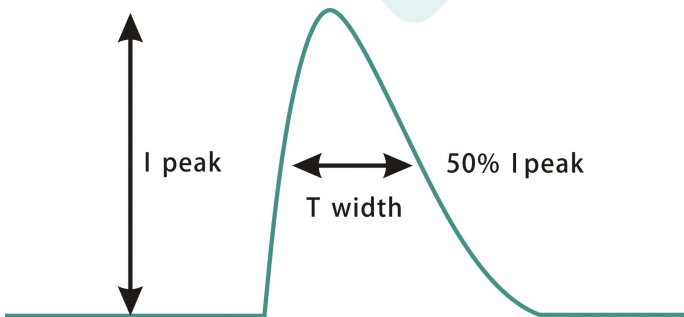
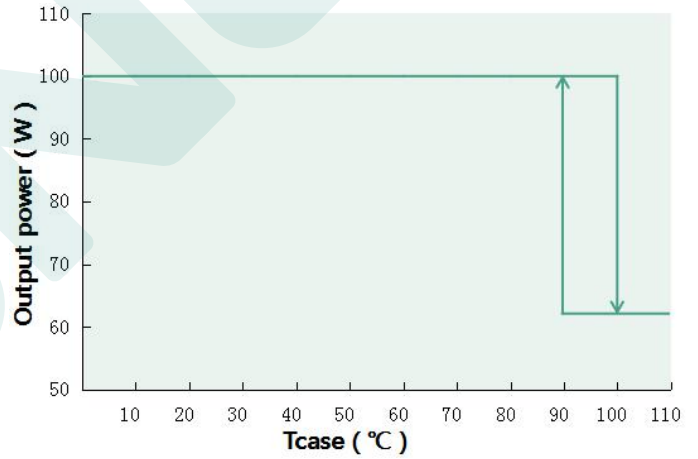

Input voltage	Peak current	T(@50% Peak current)
277Vac	76A	4us
380Vac	88A	3.2us
480Vac	89A	5.6us

Output power VS Input voltage

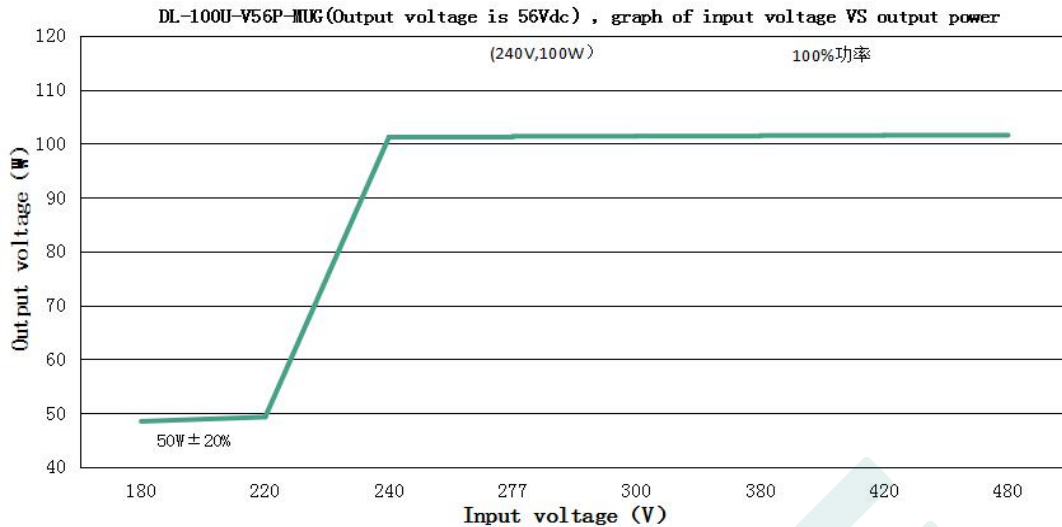

DL-100U-V56P-MUG (When the output voltage is 56Vdc, the rated output current value and output power corresponding to different input voltage)

Input Voltage	180Vac	220Vac	240Vac	277Vac	300Vac	380Vac	420Vac	480Vac
Iout	0.86A	0.86A	1.81A	1.8A	1.8A	1.8A	1.8A	1.8A
Pout	48.5W	49.3W	101.23W	101.39W	101.42W	101.53W	101.58W	101.64W

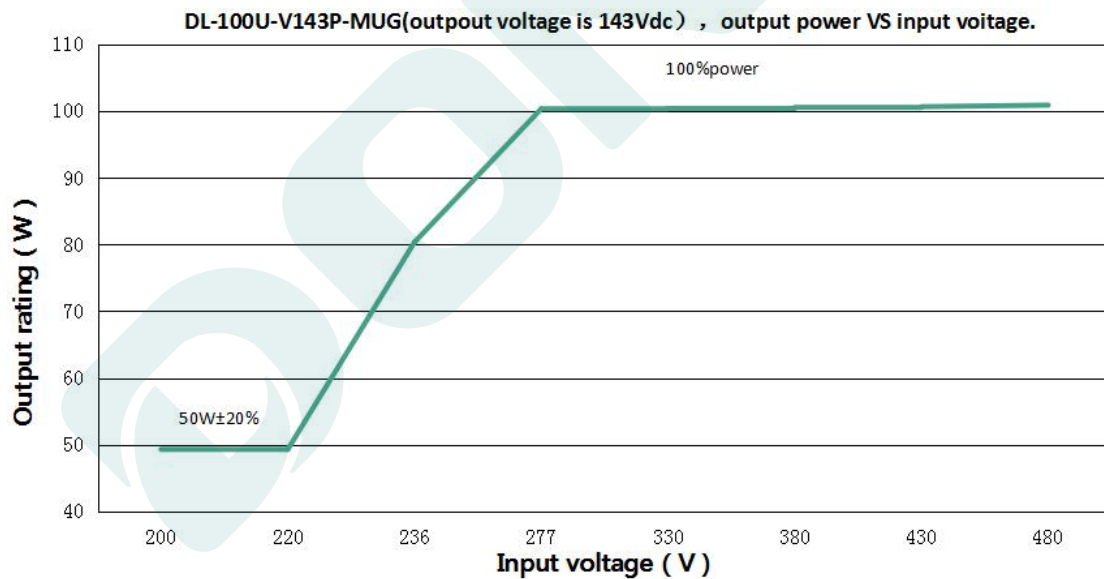

DL-100U-V143P-MUG (When the output voltage is 143Vdc, the rated output current value and output power corresponding to different input voltage)

Input Voltage	180Vac	220Vac	236Vac	277Vac	300Vac	380Vac	420Vac	480Vac
Iout	0.3429A	0.3429A	0.5613A	0.7021A	0.7025A	0.7036A	0.7043A	0.706A
Pout	49.29W	49.3W	80.36W	100.34W	100.4W	100.55W	100.65W	100.89W

Note:

1. Output power will decrease gradually when input voltage less than 240Vac ± 10%; When the input voltage is 220Vac, the output power range is 50W ± 20%.

Dimming function

※ Three-in-one dimming function (P version only)

- A. To adjust the output current, applying one of the three methods between DIM+ and DIM- : a resistor of 0-100K, or any voltage of 0-10V , or a PWM signal with amplitude of 10V. .
- B. output current of dimming port: 100uA (typical value).

◎ With 0-10V dimming voltage(for both logic,negative and positive):

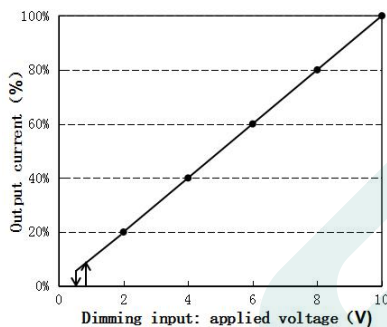
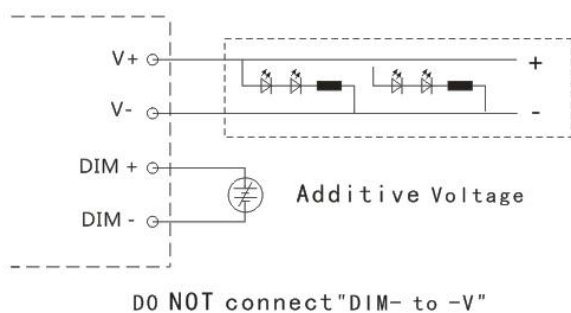

Positive logic dimming curve

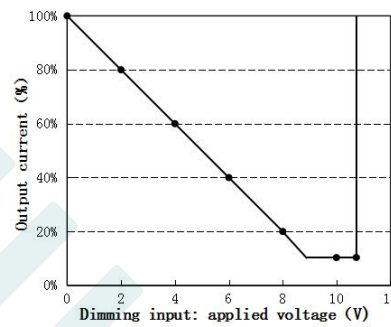

Negative logic dimming curve

◎ With 10V PWM signal (Frequency range: 300Hz-2K Hz) :

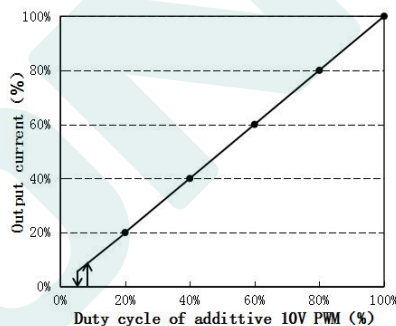
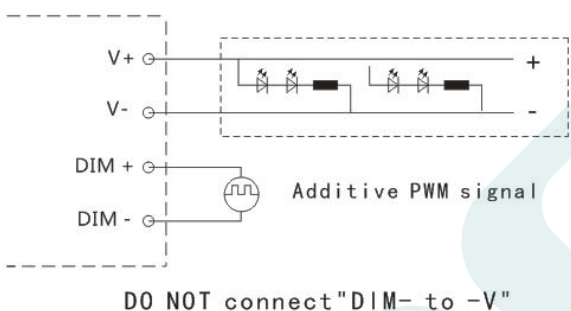

Positive logic dimming curve

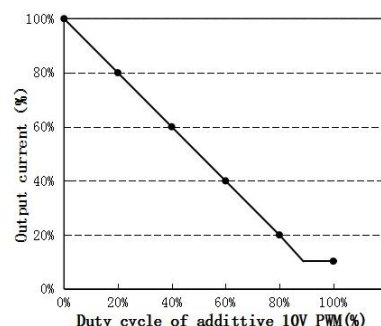

Negative logic dimming curve

◎ With an additional 0-100K resistor:

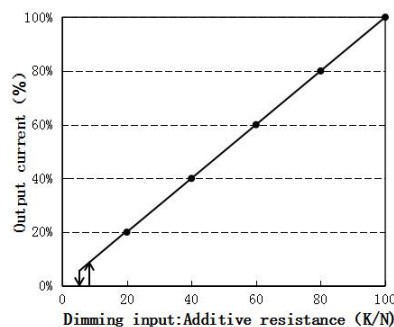
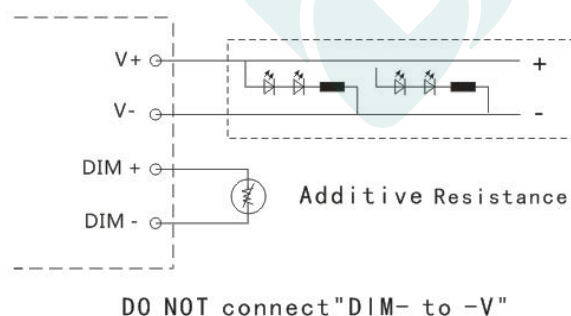

Positive logic dimming curve

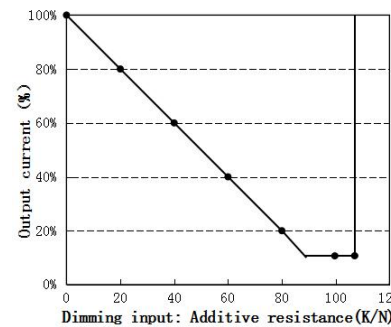

Negative logic dimming curve

Note:

1. Positive and negative logic dimming can be programmed.
2. Dimming off only applies to positive logic. For other requirements, please contact technical personnel.

Mechanical specification

Size (mm) L200mm*W68mm*H37mm

General product dimension drawing
 DL-100U-V56/143P-MUG

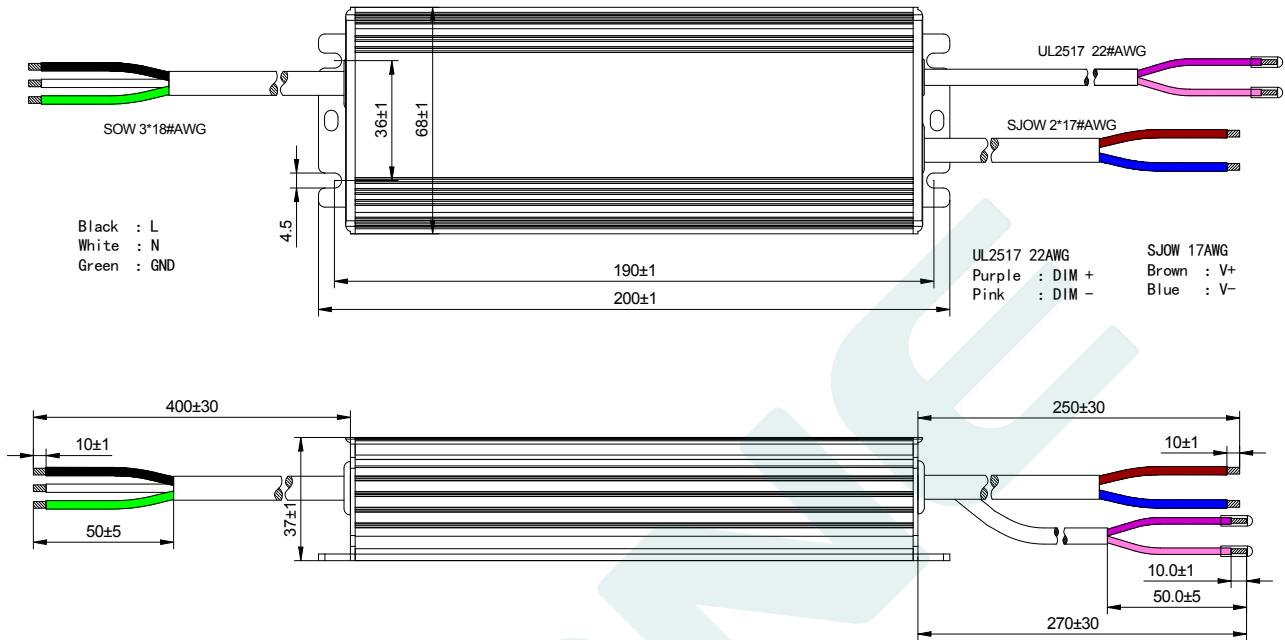

Weight

Weight 800 g

Packaging

Packaging (mm) L475*W350*H205

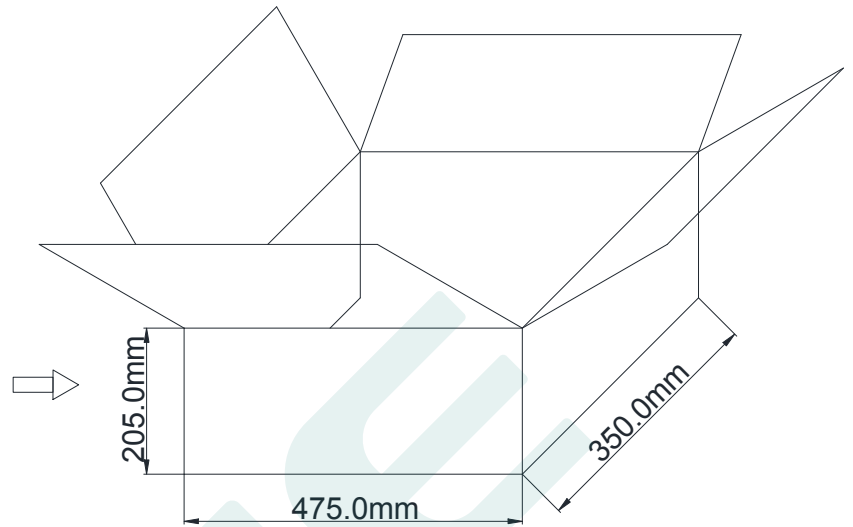
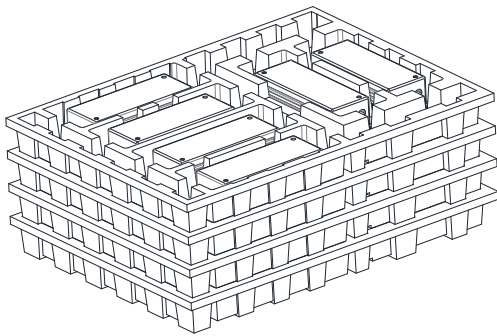

Note: One Carton 4 layers and 6 pcs each layer, total 24pcs/carton.

Note:

1. According to the qualified certificate of the LED DRIVER, that with English label is for sale in Europe, America and India.
2. That with Chinese label are used for Chinese market.

Version

DATE	DESCRIPTION	REV.	CHECK
2021.12.09	Initial version.	V1.0	
2024.1.18	Added DL-100U-V143P-MUG	V1.1	

MANUFACTRUER

EDIT

CHECK

APPROVE