

FAD- 系列防水防尘防腐灯

Series Weatherproof Light Fittings



Weatherproof Light Fittings
防水防尘防腐灯具系列



◆ 型号规格含义/Catalogue number logic

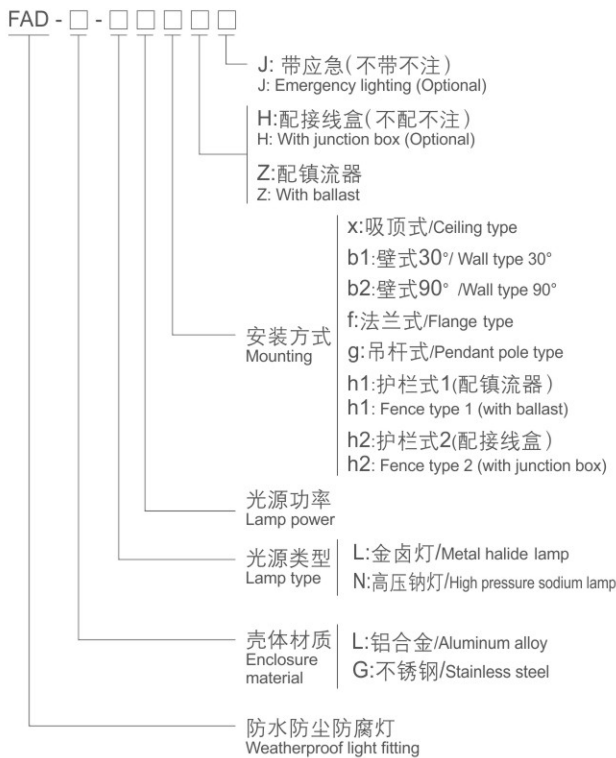

◆ 产品特点/Product features

- ◇ 铝合金拉伸壳体，表面高压静电喷塑；
- ◇ 钢化玻璃透明罩，透光率高；
- ◇ 防腐等级：WF1、WF2(可选)。
- ◇ Enclosure is formed of aluminum alloy through stretching high-voltage electrostatic, powder coated surface.
- ◇ Tempered glass transparent cover, high light transmittance.
- ◇ Corrosion-proof: WF1, WF2 (Optional).



Waterproof



Dustproof



Corrosionproof

Weatherproof Light Fittings
防水防尘防腐灯具系列

◆ 产品规格/Product Specifications

型号规格 Model Specifications	高压钠灯(N) High pressure sodium lamp N)	金卤灯(L) Metal halide lamp (L)	防护等级 Degree of protection	灯座规格 Lamp holder
FAD-L-□	70W、110(100)W	70W、100W、150W	IP65	E27
FAD-G-□ (I型/Type I)	70W、110(100)W	70W、100W、150W	IP65	E27
FAD-G-□ (II型/Type II)	150W、250W	250W	IP65	E40

◆ 外形尺寸/Outline dimension (mm)

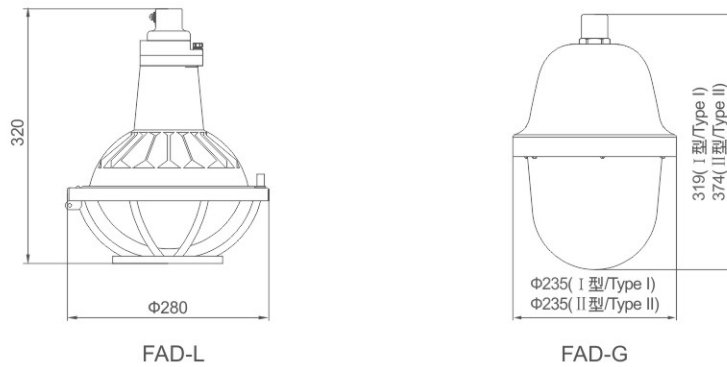

◆ 订货须知/Ordering Information

- ◇ 注明执行标准、工作电压、环境温度；
- ◇ 按照产品型号规格说明逐条选择，例如：铝合金材质，金卤灯70W吸顶式安装，配镇流器，则产品选型为FAD-L-L70 x Z；
- ◇ 常规供货不配光源，气体放电灯建议配置飞利浦、欧司朗、亚明品牌；节能灯建议配置工业型；
- ◇ 铝合金镇流器常规为钢管布线，如需电缆布线请注明；
- ◇ 如需加装应急装置时请注明。
- ◇ Specify the executive standard, working voltage, environment temperature.
- ◇ Follow the product catalogue number logic for selection. For example: aluminum alloy material 70W metal halide lamp, ceiling type, with ballast, the product type shall be FAD-L-L70 x Z.
- ◇ Light fittings are supplied without light source. For gas discharge lamp, Philips, Osram and Yaming Brands are recommended; For energy saving lamp, industrial type is recommended.
- ◇ Steel pipe wiring is provided for aluminum alloy ballast; please specify if cable wiring is needed.
- ◇ If the emergency device is required, please specify when ordering.

FAD- 系列防水防尘防腐灯

Series Weatherproof Light Fittings



Weatherproof Light Fittings
防水防尘防腐灯具系列

技术参数/Technical Parameters



执行标准 Executive standards	中国GB标准 Chinese GB standards		
额定电压 Rated voltage	220V AC 50Hz 60Hz(可选/Optional)		
环境温度 Ambient temperature	-40℃~+45℃		
防护等级 Degree of protection	IP65		
引入装置 Cable gland	G3/4"引入口规格, 适合Φ10mm~Φ14mm电缆 G3/4" entry specification, suitable for cable of Φ10mm~Φ14mm		
接线端子 Terminal	< 2.5mm ² 导线可靠连接 / < 2.5mm ² reliable wire connection		
安装方式 Mounting	吸顶式(x)、吊杆式(g)、法兰式(f)、护栏式1(h1)、护栏式2(h2)、壁式30° (b1)、壁式90° (b2) Ceiling type(x), Pendant pole type(g), Flange type(f), Fence type1(h1), Fence type2(h2), Wall type30° (b1), Wall type90° (b2)		
灯具型号 Model of light fittings	FAD-L	FAD-G (I 型/Type I)	FAD-G (II 型/Type II)
光源功率 Lamp power	N70W N110(100)W L70W L100W L150W	N70W N110(100)W L70W L100W L150W	N150W N250W L250W
灯具重量 Weight of Light fitting	2.5kg	2.5kg	4.0kg

配光曲线 / Luminous intensity distribution
cd/1000lm

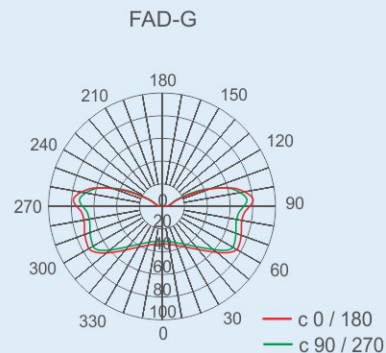
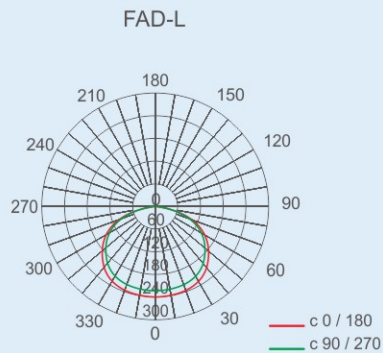



Weatherproof Light Fittings
防水防尘防腐灯具系列

◆ 外形及安装举例/Outline and mounting type

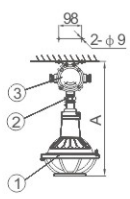

吸顶式(x)
Ceiling type(x)

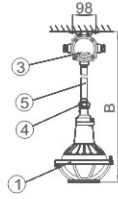

吊杆式(g)
Pendant pole type(g)

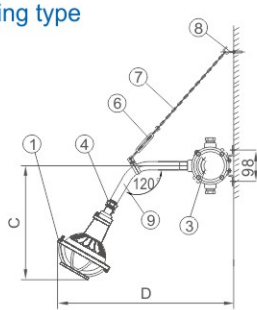

壁式30° (b1)
Wall type30° (b1)

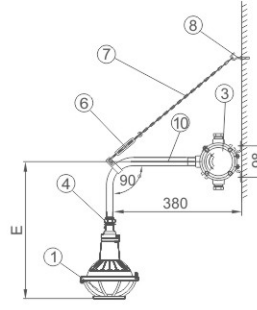

壁式90° (b2)
Wall type90° (b2)

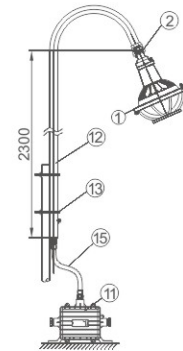

护栏式1(h1)
Fence type1(h1)

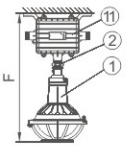

吸顶式(x)
Ceiling type(x)

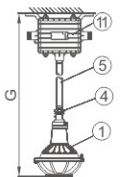

吊杆式(g)
Pendant pole type(g)

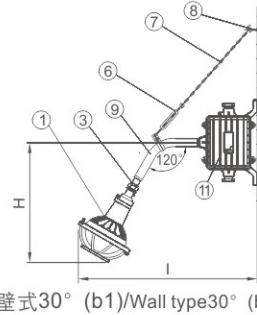

壁式30° (b1)/Wall type30° (b1)

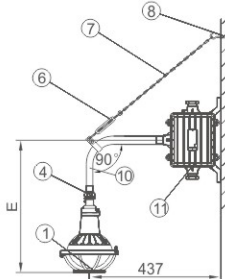

壁式90° (b2)/Wall type90° (b2)

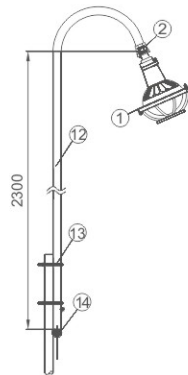

护栏式2(h2)/Fence type2(h2)

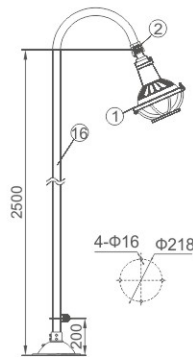

法兰式(f)/Flange type(f)

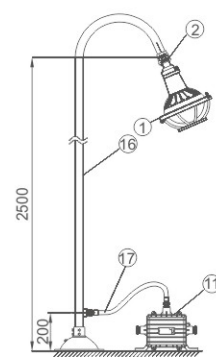

法兰式(f)/Flange type(f)

序号 No.	名称 Name	备注 Remark
1	FAD-□防水防尘防腐灯 FAD-□ Weatherproof Light Fittings	
2	防腐活接头FHJ-G ³ / ₄ "(外) / ³ / ₄ "(外) Weatherproof flexible connector FHJ- G ³ / ₄ " (male)/ G ³ / ₄ "(male)	
3	防水防尘防腐接线盒FHD-G ³ / ₄ "K Weatherproof junction box FHD-G ³ / ₄ "K	
4	防腐活接头FHJ-G ³ / ₄ "(内) / ³ / ₄ "(外) Weatherproof flexible connector FHJ- G ³ / ₄ " (female)/ G ³ / ₄ "(male)	用户自备 Supplied by user
5	直杆G ³ / ₄ " Straight pole G ³ / ₄ "	300mm
6	CC型索具螺旋扣 CC type rigging spiral buckle	450mm
7	链条 Chain	
8	M6膨胀螺钉 M6 Expansion screw	
9	30°弯杆G ³ / ₄ " 30° bend pole G ³ / ₄ "	300mm
10	90°弯杆G ³ / ₄ " 90° bend pole G ³ / ₄ "	400mm
11	FAZ防水防尘防腐镇流器 FAZ Weatherproof ballasts	
12	护栏杆G1 ¹ / ₄ " Fence pole G1 1/4"	
13	U型管夹 U type pipe clamps	用户自备 Supplied by user
14	三防密封接头FQM- I -G ³ / ₄ " Weatherproof cable gland FQM-I- G ³ / ₄ "	
15	防水防尘防腐挠性连接管FNG-G ³ / ₄ "(双外) Weatherproof flexible conduits FNG- G ³ / ₄ "(Double male)	用户自备 Supplied by user
16	法兰杆G1 ¹ / ₄ " Flange pole G1 1/4"	
17	防水防尘防腐挠性连接管FNG-G ³ / ₄ "(外)G1"(外) Weatherproof flexible conduits FNG- G ³ / ₄ "(male)G1"(male)	用户自备 Supplied by user

灯具型号/Lamp type	尺寸/Size								
	A	B	C	D	E	F	G	H	I
FAD-L	487	757	331	713	520	530	800	331	756
FAD-G (I 型/Type I)	490	760	287	666	508	533	764	287	684
FAD-G (II 型/Type II)	563	835	332	758	581	606	876	332	769