

HRFY-E 系列防水防尘防腐全塑LED灯(B型)

Series Weatherproof Light Fittings for LED Lamps (Type B)



Waterproof



Dustproof



Corrosionproof

Weatherproof Light Fittings
防水防尘防腐灯具系列



◆ 型号规格含义/Catalogue number logic

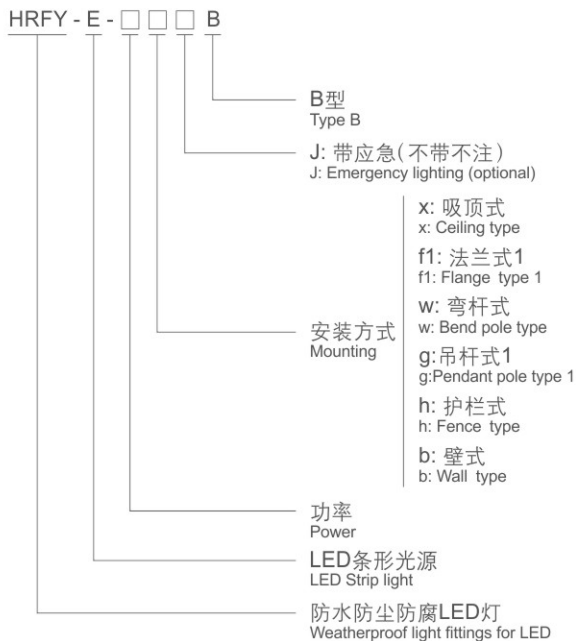

◆ 产品特点/Product features

- ◇ 双色挤塑成型透明罩;
- ◇ 内置散热铝型材, 保证光源有效散热, 确保灯具长寿命可靠工作;
- ◇ 特制的恒流恒压源, 宽电压输入, 恒功率输出, 具有分流、恒流、开路、短路等保护;
- ◇ 配置贴片式条形LED光源, 合理排布, 单向发光, 光线均匀柔和, 光效高, 显色性高, 绿色环保;
- ◇ 防腐等级: WF2。
- ◇ Transparent cover is bi-color extrusion molding.
- ◇ Built-in heat dissipation aluminium profile, ensure effective heat dissipation of lamp, long life and reliable work of light fittings.
- ◇ Special-made constant current constant voltage source, wide voltage input, constant power output, with shunt, constant current, open circuit, short circuit, etc. protection.
- ◇ Equipped with LED strip lamp, reasonable arrangement, unidirectional lighting, even and soft light, high luminous efficiency, high color rendering, environmental protection.
- ◇ Corrosion-proof: WF2.



Weatherproof Light Fittings
防水防尘防腐灯具系列

◆ 产品规格/Product specifications

型号规格 Model Specifications	灯具功率 Lamp power	色温 Color temperature	显色指数 CRI	灯具光通量 Luminaire luminous flux	壳体类型 Enclosure type	重量 Weight
HRFY-E9 □ B	9W	5000K	Ra≥80	1030lm	I	0.8kg
HRFY-E18 □ B	18W	5000K	Ra≥80	1920lm		
HRFY-E36 □ B	36W	5000K	Ra≥80	4080lm	II	1.2kg

◆ 外形尺寸/Outline dimension (mm)

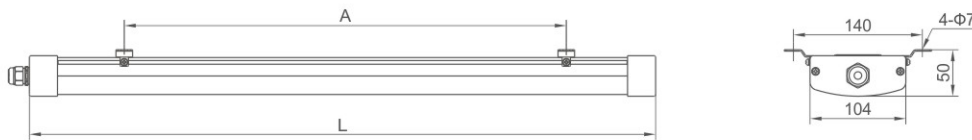

壳体类型/Enclosure type	L	A
I 型 Type I	680	500
II 型 Type II	1300	800

◆ 订货须知/Ordering Information

- ◇ 注明执行标准、工作电压、环境温度；
- ◇ 按照产品型号规格说明逐条选择，例如：需要36W LED荧光灯，法兰式1安装，则产品选型为HRFY-E36 f1 B；
- ◇ 本灯具出厂时已配光源；
- ◇ 如需加装应急装置时请注明；
- ◇ 可配置快速接头。
- ◇ Specify the executive standard, working voltage, environment temperature;
- ◇ Follow the product catalogue number logic for selection, For example:
36W LED fluorescent lamp with two tubes, flange type 1, the product type shall be HRFY-E36 f1 B.
- ◇ Light fittings are supplied with light source.
- ◇ If the emergency device is required, please specify when ordering.
- ◇ Can equip quick coupling.

HRFY-E 系列防水防尘防腐全塑LED灯(B型)

Series Weatherproof Light Fittings for LED Lamps (Type B)



Waterproof



Dustproof



Corrosionproof

Weatherproof Light Fittings
防水防尘防腐灯具系列

技术参数/Technical Parameters



执行标准 / Executive standards	中国GB标准 Chinese GB standards
额定电压 / Rated voltage	220V~240V AC 50Hz / 60Hz
环境温度 / Ambient temperature	-25℃~+45℃
防护等级 / Degree of protection	IP66
引入装置 / Cable gland	M20 × 1.5引入规格, 适合Φ6mm~Φ10mm电缆 M20 × 1.5 entry specification, suitable for cable of Φ6mm~Φ10mm
接线端子 / Terminal	≤ 2.5mm ² 导线可靠连接(≤ 4mm ² 可选) ≤ 2.5mm ² reliable wire connection (≤ 4mm ² is optional)
安装方式 / Mounting	吸顶式(x)、吊杆式(g)、法兰式(f)、护栏式(h)、弯杆式(w)、壁式(b) Ceiling type (x), pendant pole type (g), flange type (f), fence type (h), bend pole type (w), wall type (b)

配光曲线 / Luminous intensity distribution cd/1000lm

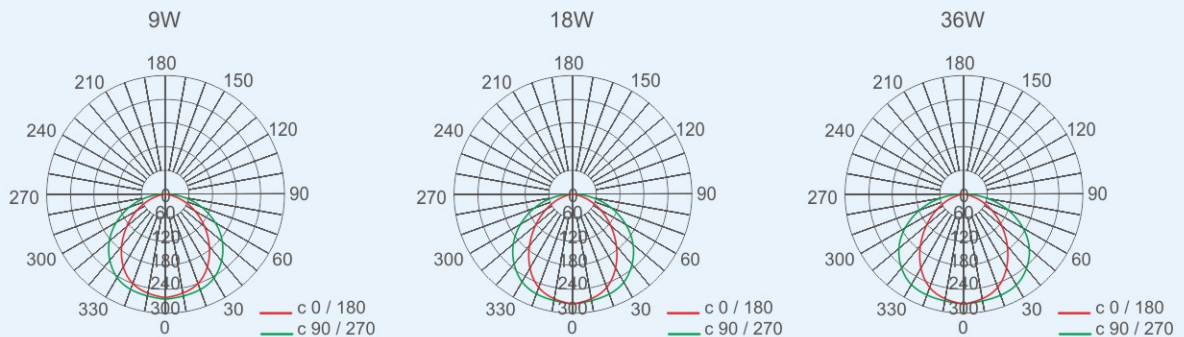

◆ 外形及安装举例/Outline and mounting type

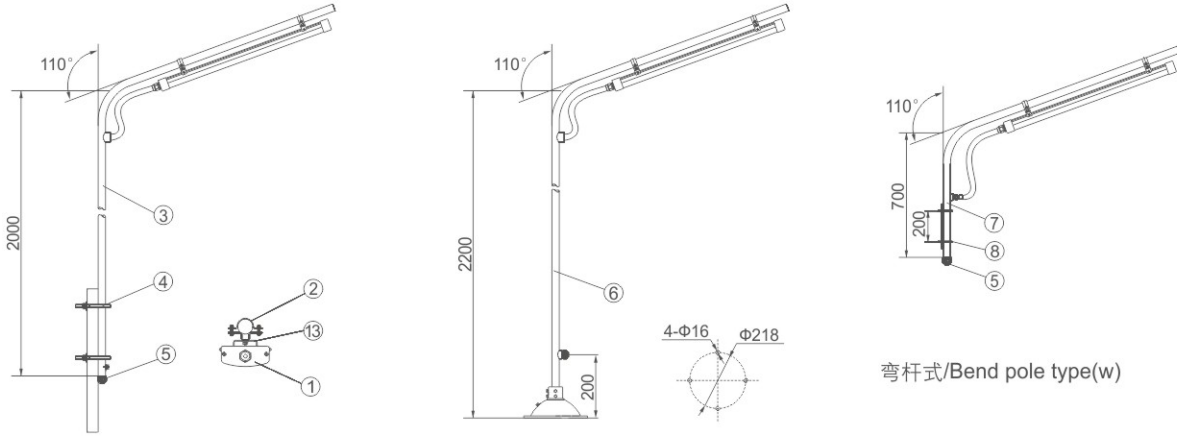

护栏式/Fence type(h)

法兰式1/Flange type 1(f1)

弯杆式/Bend pole type(w)

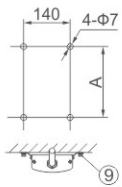

吸顶式/Ceiling type(x)

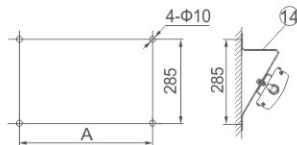

壁式/Wall type(b)

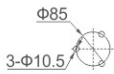

吊杆式(g)
Pendant pole type(g)

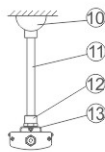

序号 No.	名称 Name	备注 Remark
1	HRFY-E防水防尘防腐全塑LED灯(B型) HRFY-E Weatherproof Light Fittings for LED Lamps (Type B)	
2	安装架、管夹 Mounting frame, pipe clamps	
3	护栏杆G1 1/4" Fence pole G1 1/4"	
4	U型管夹 U type pipe clamps	用户自备 supplied by user
5	三防密封接头FQM-I -G3/4" Weatherproof cable gland FQM-I- G3/4"	
6	法兰杆 G1 1/4" Flange rod G1 1/4"	
7	弯杆 G1 1/4" Bend pole G1 1/4"	
8	固定架 Fixed bracket	
9	安装架 Mounting frame	
10	吸盘 Sucker	
11	直杆 G3/4" Straight pole G3/4"	300mm
12	连轴器 Couplings	
13	安装支架 Mounting frame	450mm
14	三角安装架 Triangle mounting frame	