

## Distribution Boxes HRMD91 Series Explosion-proof Distribution Panels

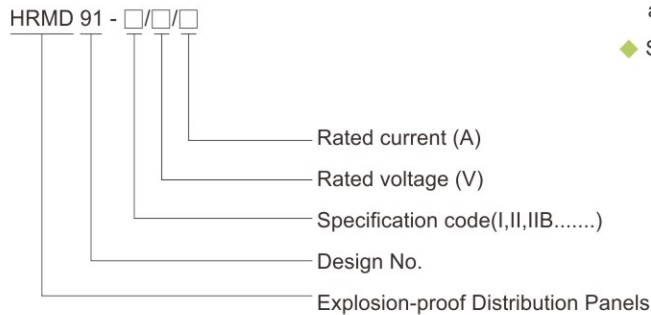

- ◆ Explosion protection to
  - CENELEC
  - IEC
  - NEC
- ◆ Can be used in
  - Zone 1 and Zone 2
  - Zone 21 and Zone 22
  - Class I, Zone 1 and Zone 2
  - Class I, Division 1, Groups B, C, D
- ◆ Flameproof enclosure (Ex d IIB+H2), which can be used as feed distribution equipment in control and distribution system (such as distribution box, switch box of main circuit, control box, terminal box or motor starting box etc.)
- ◆ Copper-free Aluminium Alloy enclosure, powder coated surface.
- ◆ Equipped with specialized hinge structure, which can prevent the flameproof joints from damage when opening and closing the box, and greatly prolong the service life of box.
- ◆ The boxes can be combined and installed freely to save space and meet the requirements of various distribution systems.
- ◆ Special requirements on request.

### ■ Catalogue number logic



# Zones 1 & 2; 21 & 22

## Distribution Boxes

### HRMD91 Series Explosion-proof Distribution Panels

Technical data	
Explosion-proof Distribution Panels <b>HRMD91-□/□/□</b>	
<b>Explosion protection</b>	
Global (IECEX)	IECEX CML 18.0157X
Gas and dust	Ex db IIB+H <sub>2</sub> T□ <sup>1)</sup> Gb Ex db [ib] IIB+H <sub>2</sub> T□ <sup>1)</sup> Gb Ex tb IIIC T□ <sup>1)</sup> Db IP66
Europe (ATEX)	CML 18 ATEX 1338X
Gas and dust	⊕ II 2 G Ex db IIB+H <sub>2</sub> T□ <sup>1)</sup> Gb ⊕ II 2 G Ex db [ib] IIB+H <sub>2</sub> T□ <sup>1)</sup> Gb ⊕ II 2 D Ex tb IIIC T□ <sup>1)</sup> Db IP66 <sup>1)</sup> See Selection table, P6/24-25
<b>Certificates</b>	IECEX; ATEX; CUTR
<b>Conformity to standards</b>	EN 60079-0, EN 60079-1, EN 60079-11, EN 60079-31 IEC 60079-0, IEC 60079-1, IEC 60079-11, IEC 60079-31
<b>Enclosure material</b>	Copper-free Aluminium Alloy enclosure, powder coated surface, window grey (RAL7040)
<b>Exposed fastener</b>	Stainless steel
<b>Built-in components</b>	Ammeters voltmeters, power meters, tachometers temperature control meters and other meters, control switches, disconnecting switches, Moulded Case Circuit Breakers (MCCB), Miniature Circuit Breakers(MCB), AC contactors, thermal relays, intermediate relays, time relays, control transformers, DC power supplies, current transformers, surge protectors, PLCs, fuses, soft starters, frequency converters, terminals, bus bars, resistors, light-operated switches, time controllers, optical fiber control boxes, magnet valves, analytical instruments, heaters, self-regulation trace heating cables, display screens, magnetic ballasts of HID light sources, electronic ballasts of fluorescent lamps, drivers of LED light sources, emergency devices of HID light sources, emergency devices of fluorescent lamps, emergency devices of LED light sources, safety barriers, integrated protectors of motors, lighting building controllers, lighting energy saving controllers, fire monitoring controllers, temperature controllers, humidity controllers, current monitors, voltage monitors, motor protection switches, dual power transfer switches, counters, timers, solid state relays, diode modules, industrial personal computers, UPS, batteries.
<b>Rated voltage</b>	Max. 1000V AC 50/60Hz Max. 1500V DC
<b>Rated current</b>	Max. 1200A
<b>Degree of protection</b>	IP66
<b>Internal&amp;external earthing</b>	M6/M8, M8/M8
<b>Ambient temperature</b>	-60℃~+60℃
<b>Cable entries</b>	Standard M□ x 1.5 plug (the size of entry hole should be processed in accordance with actual requirements), NPT □ plug on request.
<b>Cable gland (optional)</b>	DQM-II (Ex d) or DQM-III (Ex d) is recommended. Please see P7/20~31.
<b>Entry direction</b>	Bottom
<b>Mounting</b>	Surface type (standard) Pedestal type (optional)



## Distribution Boxes

### HRMD91 Series Explosion-proof Distribution Panels

See table for max. dissipated power

Ta=60°C	HRMD91 with metal cover without glass					
	T4(T130°C)		T5(T95°C)		T6(T80°C)	
	Type	Power (W)	T Rise (K)	Power (W)	T Rise (K)	Power (W)
HRMD91-I	200	70	80	33	38	17
HRMD91-II	200	65	80	31	40	17
HRMD91-IIB	240	67	100	31	50	17
HRMD91-III	290	66	130	32	60	17
HRMD91-IIIB	350	67	140	32	75	17
HRMD91-IV	420	62	190	33	100	17
HRMD91-IVB	500	65	210	34	100	17
HRMD91-V	520	60	240	31	125	17
HRMD91-VB	620	61	280	31	140	17
HRMD91-VI	660	61	300	31	150	17
HRMD91-VIB	660	53	330	31	180	17
HRMD91-VII	700	50	400	28	210	17
HRMD91-VIIB	700	49	400	27	220	17

Ta=60°C	HRMD91 with metal cover with glass					
	T4(T130°C)		T5(T95°C)		T6(T80°C)	
	Type	Power (W)	T Rise (K)	Power (W)	T Rise (K)	Power (W)
HRMD91-I	170	69	70	33	38	17
HRMD91-II	170	69	70	33	38	17
HRMD91-IIB	200	69	80	33	38	17
HRMD91-III	260	66	110	33	55	17
HRMD91-IIIB	320	67	120	31	65	17
HRMD91-IV	380	69	160	35	72	17
HRMD91-IVB	425	68	170	34	81	17
HRMD91-V	450	66	200	34	90	17
HRMD91-VB	540	66	220	34	100	17
HRMD91-VI	620	70	260	34	140	17
HRMD91-VIB	660	58	330	34	170	17
HRMD91-VII	700	56	400	32	185	17
HRMD91-VIIB	700	56	400	32	190	17

Ta=40°C	HRMD91 with full metal cover without glass					
	T4(T130°C)		T5(T95°C)		T6(T80°C)	
	Type	Power (W)	T Rise (K)	Power (W)	T Rise (K)	Power (W)
HRMD91-I	240	85	150	54	90	37
HRMD91-II	250	84	150	54	90	37
HRMD91-IIB	300	85	170	54	110	37
HRMD91-III	360	84	210	54	140	37
HRMD91-IIIB	430	83	230	54	190	37
HRMD91-IV	550	82	310	54	210	37
HRMD91-IVB	640	84	330	54	220	37
HRMD91-V	710	83	410	54	270	37
HRMD91-VB	830	82	480	54	300	37
HRMD91-VI	870	81	520	54	320	37
HRMD91-VIB	980	79	570	54	390	37
HRMD91-VII	1100	79	770	54	460	37
HRMD91-VIIB	1100	77	800	54	480	37





## Distribution Boxes

### HRMD91 Series Explosion-proof Distribution Panels

Ta=40°C	HRMD91 with full metal cover with glass					
	T4(T130°C)		T5(T95°C)		T6(T80°C)	
	Power (W)	T Rise (K)	Power (W)	T Rise (K)	Power (W)	T Rise (K)
HRMD91-I	220	85	120	53	80	37
HRMD91-II	220	84	120	53	80	37
HRMD91-IIB	240	79	140	53	90	37
HRMD91-III	330	85	180	54	120	37
HRMD91-IIIB	400	84	200	53	140	37
HRMD91-IV	450	83	240	53	170	37
HRMD91-IVB	510	82	260	53	180	37
HRMD91-V	550	81	310	53	210	37
HRMD91-VB	610	80	350	53	240	37
HRMD91-VI	700	79	400	53	310	37
HRMD91-VIB	888	78	510	53	370	37
HRMD91-VII	970	78	650	53	450	37
HRMD91-VIIB	975	78	660	53	460	37

#### Dimension drawings (all dimensions in mm) - subject to alteration

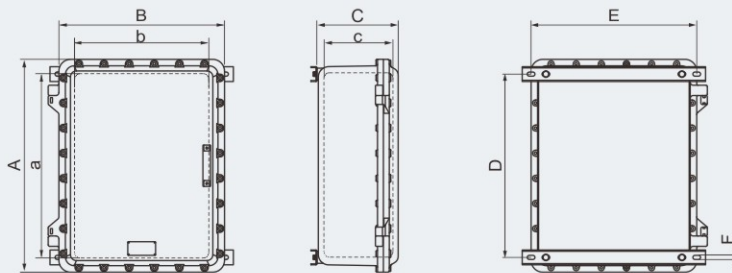

Version	External dimension			Internal dimension			Mounting dimension			Weight of enclosure (kg)
	A	B	C	a	b	c	D	E	F	
HRMD91-I	250	200	170	192	142	131	180	200	10	6.70
HRMD91-II	300	200	170	242	142	131	230	200	10	8.00
HRMD91-IIB	350	200	170	292	142	131	280	200	10	9.50
HRMD91-III	350	300	200	290	240	159	280	300	12	14.50
HRMD91-IIIB	350	300	270	290	240	229	280	300	12	17.50
HRMD91-IV	450	350	210	378	278	163	365	350	12	23.00
HRMD91-IVB	450	350	280	378	278	233	365	350	12	27.50
HRMD91-V	560	400	210	488	328	155	475	400	14	34.50
HRMD91-VB	560	400	280	488	328	225	475	400	14	39.50
HRMD91-VI	634	434	265	560	360	205	522	430	14	46.00
HRMD91-VIB	634	434	335	560	360	275	522	430	14	52.00
HRMD91-VII	720	560	275	640	480	215	620	560	14	74.50
HRMD91-VIIB	720	560	345	640	480	285	620	560	14	83.00

Note: For cable entries:

- 1). Please specify the direction and size of each cable entry.
- 2). Cable gland is optional, DQM-II (Ex d) or DQM-III (Ex d) is recommended, please see P7/20~31.

## Distribution Boxes

### HRMD91 Series Explosion-proof Distribution Panels

#### HRMD91 Explosion-proof distribution panels for terminal box use

Suitable for terminal boxes of distribution system

Note: 1. HRMD91 terminal boxes have various different terminal arrangement methods.

2. It can be customized in accordance with user's requirements and conforms to the usage limits of conformity certificate. The Max. number of terminals and the Max. number of holes on side can meet the requirements of dissipated power and enclosure mechanical strength.
3. This table is only for reference.

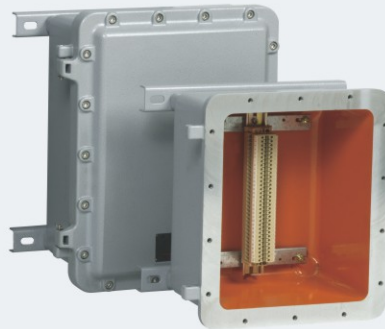

#### HRMD91 Explosion-proof distribution panels for distribution box use

Suitable for power units of distribution system

Note: 1. MCB (Miniature Circuit Breaker) or MCCB (Moulded Case Circuit Breaker), AC contactor, thermal overload relay, PLC programmer, soft starter, HA pushbuttons, HD indicators, HK control switches and BB8050 explosion-proof ammeters/voltmeters etc. in HRMD91 distribution boxes.

2. HRMD91 power unit can be used for distribution or on-off of circuit. It also can be used for controlling the start, stop, corotation and inversion of motor and provide comprehensive protection for motor. It can be equipped with two-site control or multi-site control.
3. It can be customized in accordance with user's requirements and conforms to the usage limits of conformity certificate. The number of cover components and the Max. number of holes on side can meet the requirements of dissipated power and enclosure mechanical strength.

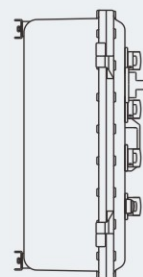
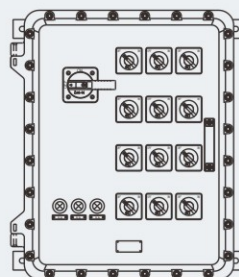

## Distribution Boxes HRMD91 Series Explosion-proof Distribution Panels

### HRMD91 Explosion-proof Distribution panels for control box use

Suitable for control unit of distribution system

Note: 1. HA pushbuttons, HD indicators, HK control switches and BB8050 explosion-proof ammeters/voltmeters etc.in HRMD91 control boxes.

2. HRMD91 control box can be used for on-off operation of circuit. It also can realize the remote control or local control of the start, stop, corotation and inversion of motor. When it is equipped with ammeter, it also can monitor the running of motor and circuit status.

3. It can be customized in accordance with user's requirements and conforms to the usage limits of conformity certificate. The number of cover components and the Max. number of holes on side can meet the requirements of dissipated power and enclosure mechanical strength.

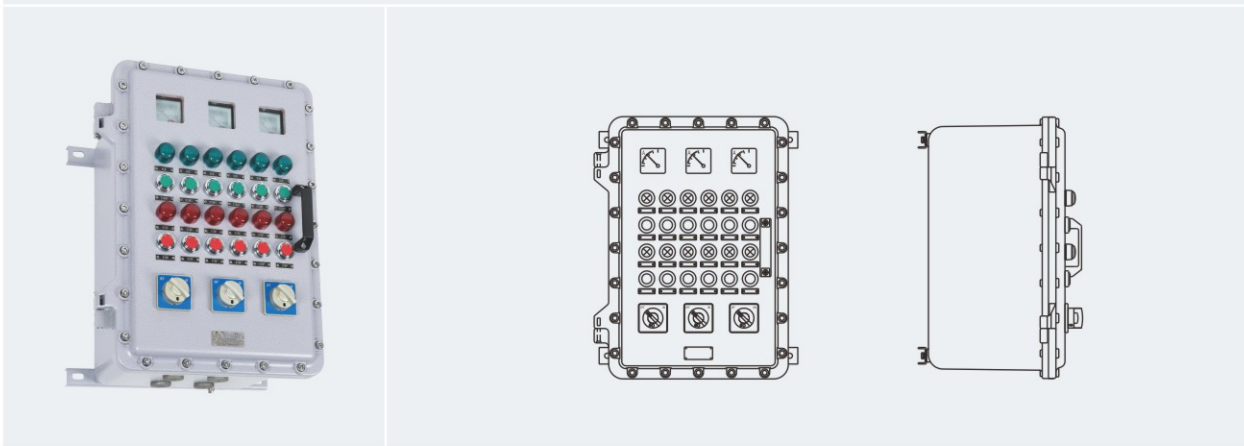

### Typical scheme diagram

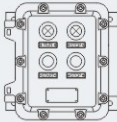
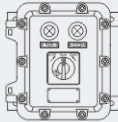
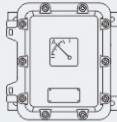
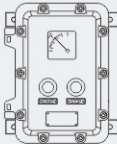
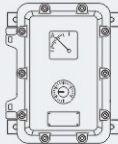
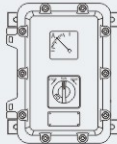
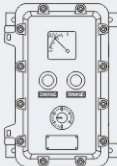
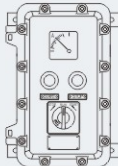
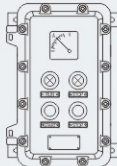
Enclosure type	Components arrangement		
HRMD91-I			
HRMD91-II			
HRMD91-IIB			



## Distribution Boxes HRMD91 Series Explosion-proof Distribution Panels

### Typical scheme diagram

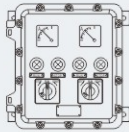
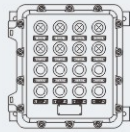
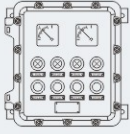
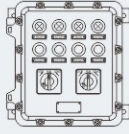
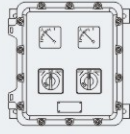
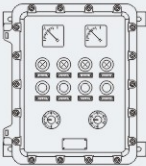
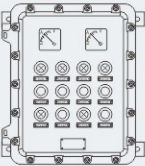
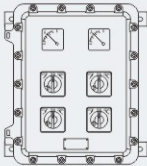
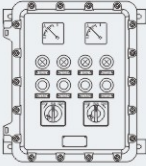
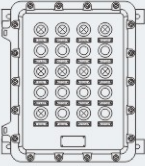
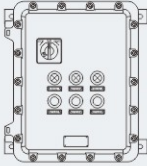
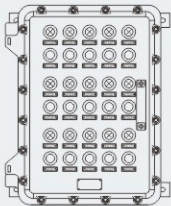
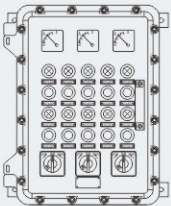
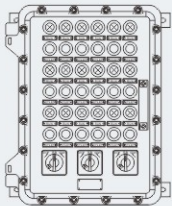
Enclosure type	Components arrangement		
HRMD91-III			
HRMD91-IIIB			
HRMD91-IV			
HRMD91-IVB			
HRMD91-V			





## Distribution Boxes HRMD91 Series Explosion-proof Distribution Panels

Typical scheme diagram			
Enclosure type	Components arrangement		
HRMD91-VB			
HRMD91-VI			
HRMD91-VIB			
HRMD91-VII			
HRMD91-VIIB			

